



**DISTRICT-WIDE RENTAL AND/OR PURCHASE OF
RELOCATABLE MODULAR BUILDINGS**

Bid No. 1512

Bid Deadline: Tuesday, May 31, 2016 at 11:00 AM
Garden Grove Unified School DISTRICT
Office of Business Services – Purchasing Department
10331 Stanford Avenue
Garden Grove, CA 92840

Contact: Connie Cross, Assistant Director of Business Services
(714) 663-6133
ccross@ggusd.us

GARDEN GROVE UNIFIED SCHOOL DISTRICT
Purchasing Department
10331 Stanford Avenue, Garden Grove, CA 92840
(714) 663-6133

NOTICE CALLING FOR BIDS
**DISTRICT-WIDE RENTAL AND/OR PURCHASE OF
RELOCATABLE MODULAR BUILDINGS**
BID No. 1512

District: **Garden Grove Unified School District**

Bid Deadline: **Tuesday, May 31, 2016 at 11:00 AM**

Place of Bid Receipt: **Garden Grove Unified School District Business Office
10331 Stanford Avenue
Garden Grove, California 92840**

NOTICE IS HEREBY GIVEN that the Garden Grove Unified School District of Orange County, California, acting by and through its Board of Education, hereinafter referred to as "District," will receive up to, but not later than, the above-stated bid deadline, sealed bids at the place identified above for the award of a contract for the above referenced bid.

The district is seeking proposals for **DISTRICT-WIDE RENTAL AND/OR PURCHASE OF RELOCATABLE MODULAR BUILDINGS, Bid No. 1512**, in accordance with Instructions, Conditions, and Specifications now on file in the Purchasing Department of said School District.

Time is of the essence. Each bid must conform and be responsive to the bid documents, which are on file in the Business Office. Bid documents are also available online at: WWW.GGUSD.US; printed copies are available upon request by contacting Connie Cross at (714) 663-6133. No bidder may withdraw any bid for a period of sixty (60) calendar days after the date set for the opening of bids.

The District reserves the right to reject any or all bids or to waive any irregularities or informalities in any bids or in the bidding process. The right is also reserved by the Board to select items which, in their opinion, will best serve the needs of the District.

Any and all questions shall be directed to the Business Office at (714) 663-6133.

Dated this 11th day of May, 2016.

GARDEN GROVE UNIFIED SCHOOL DISTRICT

By: _____
Connie Cross
Assistant Director of Business Services

Publication Dates: May 13, 2016 and May 20, 2016
Orange County News – PO J72V0012

BID OBJECTIVE

The Garden Grove Unified School District (GGUSD) is seeking bids for **DISTRICT-WIDE RENTAL AND/OR PURCHASE OF RELOCATABLE MODULAR BUILDINGS, Bid No. 1512**. This is a 3-year contract. The District will award to the bidder or bidders providing the lowest 9-monthly rental payment for used and new modular buildings and the lowest bid amount purchase price for used and new modular buildings as identified in the Bid Form Matrix. Bidder must agree that any contract awarded by the District will be contingent on adequate funding and that any awarded contract may be terminated at any time by the District.

DISTRICT-WIDE RENTAL AND/OR PURCHASE OF RELOCATABLE MODULAR BUILDINGS, Bid No. 1512 will consist of the following:

- Month-to-month rental of DSA certified portable classrooms
- Month-to-month rental of DSA certified portable restrooms
- Month-to-month rental of other DSA certified buildings
- Necessary ramps, skirting and landings
- Installation, set-up; Delivery freight; Return freight
- Knockdown
- Block & level DSA foundation materials
- Labor related to block and level DSA foundation materials

Each rental and/or purchase of relocatable modular buildings will be on an as-needed basis and will be provided for district pupils, certificated staff and classified staff.

DISTRICT-WIDE RENTAL AND/OR PURCHASE OF RELOCATABLE MODULAR BUILDINGS, Bid No. 1512 will provide the Garden Grove Unified School District with modular facilities and relocatable buildings to meet its educational needs. The bidder or bidders will be required to deliver equipment in an expeditious manner. Bidders will be paid according to the rates awarded.

PIGGYBACK: OTHER PUBLIC AGENCIES. Pursuant to Public Contract Code Sections 20118 and 20652 and other applicable provisions, other public agencies, including school districts and community colleges in the State of California, may acquire items identified in this bid under the same terms and conditions of this bid. If so, the District waives its rights for a warrant to be drawn in its favor or for any reasonable costs, and directs each public agency to work directly with the successful bidder.

It is the Bidder's sole responsibility to ensure that their bid is received prior to the scheduled closing time for receipt of proposals. In accordance with Government Code § 53068, any bid received after the scheduled closing time for receipt of bids shall be returned to the Bidder unopened. At the time set forth in the Notice To Bidders - Invitation For Bids for the opening of bids, the sealed bids will be opened and read at the District office.

All **inquiries** regarding this bid must be submitted on or before Thursday, May 26, 2016, no later than 5:00 PM, to Connie Cross, Assistant Director of Business Services by email at

purchasing@ggusd.us or by fax at 714-663-6250.

Bidders are advised that oral or written communications from the District in any form other than an official addendum does not alter the bid or specifications.

Bidder must agree that **DISTRICT-WIDE RENTAL AND/OR PURCHASE OF RELOCATABLE MODULAR BUILDINGS, Bid No. 1512** is nonexclusive and that the District will determine, in its sole discretion, category(ies) to be provided that is/are best for students and staff, and the most cost effective for the District.

INFORMATION FOR BIDDERS

NOTE: READ THIS DOCUMENT CAREFULLY. DO NOT ASSUME THAT IT IS THE SAME AS OTHER SIMILAR DOCUMENTS YOU MAY HAVE SEEN, EVEN IF FROM THE SAME DISTRICT.

1. Preparation of Bid Form. Bids shall be submitted on the prescribed Bid Form and Bid Form Matrix, completed in full. All bid items and statements shall be properly and legibly filled out. Numbers shall be stated both in words and in figures where so indicated, and where there is a conflict in the words and the figures, the words shall control over the numbers. The signatures of all persons shall be in longhand and in ink. Prices, wording and notations must be in ink or typewritten.

2. Form and Delivery of Bids. The bid must conform and be responsive to all bid documents and shall be made on the Bid Form and Bid Form Matrix provided, and the complete bid, together with any and all additional materials as required, shall be enclosed in a sealed envelope, addressed and hand delivered or mailed to the **Garden Grove Unified School District, 10331 Stanford Avenue, Garden Grove, California** and must be received on or before the bid deadline (Public Contract Code Section 20112). The envelope shall be plainly marked in the upper left hand corner with the bidder's name, the bid designation and the date and time for the opening of bids. **It is the bidder's sole responsibility to ensure that its bid is received prior to the bid deadline.** In accordance with Government Code Section 53068, any bid received after the scheduled closing time for receipt of bids shall be returned to the bidder unopened. At the time and place set forth for the opening of bids, the sealed bids will be opened and publicly read aloud.

3. Signature. Any signature required on bid documents must be signed in the name of the bidder and must bear the signature of the person or persons duly authorized to sign these documents. Where indicated, if bidder is a corporation, the legal name of the corporation shall first be set forth, together with two signatures: one from among the chairman of the board, president or vice president and one from among the secretary, chief financial officer, or treasurer. Alternatively, the signature of other authorized officers or agents may be affixed, if duly authorized by the corporation. Such documents shall include the title of such signatories below the signature and shall bear the corporate seal. Where indicated, in the event that the bidder is a joint venture or partnership, there shall be submitted with the bid certifications signed by authorized officers of each of the parties to the joint venture or partnership, naming the individual who shall sign all necessary documents for the joint venture or partnership and, should the joint venture or partnership be the successful bidder, who shall act in all matters relative to the joint venture or partnership. If bidder is an individual, his/her signature shall be placed on such documents.

4. Modifications. Changes in or additions to any of the bid documents, summary of the work bid upon, or any other modifications which are not specifically called for by the District may result in the District's rejection of the bid as being nonresponsive. No oral, telephonic, facsimile or electronic modification of any of the bid documents will be considered.

5. Erasures, Inconsistent or Illegible Bids. The bid submitted must not contain any erasures, interlineations, or other corrections unless each such correction is authenticated by affixing the initials of the person(s) signing the bid in the margin immediately adjacent to the correction. In the event of inconsistency between words and numbers in the bid, words shall control numbers. In the event that District determines that any bid is unintelligible, illegible or ambiguous, the District may reject such bid as being nonresponsive.

6. Examination of Bid Documents. At its own expense and prior to submitting its bid, each bidder shall examine all documents relating to the bid; familiarize itself with all federal, state and local laws, ordinances, rules, regulations and codes affecting the performance of the services, including the cost of permits and licenses required for the services; determine the character, quality, and quantities of the services to be performed and the materials and equipment to be provided; and correlate its observations, investigations, and determinations with all requirements of the bid. The bid documents are only provided as information for the bidder. The District is not making any warranties regarding said information. The District shall not be liable for any loss sustained by the successful bidder resulting from any variance between the conditions given in the bid documents and the actual conditions revealed during the progress of the services. **Bidder agrees that the submission of a bid shall be incontrovertible evidence that the bidder has complied with all the requirements of this provision of the Information for Bidders.**

7. Withdrawal of Bids. Any bid may be withdrawn, either personally or by written request signed by the bidder, at any time prior to the scheduled closing time for receipt of bids. No bidder may withdraw any bid for a period of sixty (60) calendar days after the date set for the opening of bids.

8. Agreement. The Agreement which the successful bidder or bidders will be required to execute is included in the bid documents.

9. Interpretation of Bid Documents. If any bidder is in doubt as to the true meaning of any part of the bid documents, or finds discrepancies in, or omissions from the bid documents, a written request for an interpretation or correction thereof or answers to questions must be submitted to the District ten (10) days before bid deadline. No requests shall be considered after this time. The bidder submitting the written request shall be responsible for its prompt delivery. Any interpretation or correction of the bid documents and answers to questions will be made solely at District's discretion and only by written addendum duly issued by the District, and a copy of such addendum will be hand delivered, e-mailed or faxed to each bidder known to have received a set of the bid documents. No person is authorized to make any oral interpretation of any provision in the bid documents, nor shall any oral interpretation of bid documents be binding on the District. If there are discrepancies of any kind in the bid documents, the interpretation of the District shall prevail. **SUBMITTAL OF A BID WITHOUT A REQUEST FOR CLARIFICATIONS SHALL BE INCONTROVERTIBLE EVIDENCE THAT THE BIDDER HAS DETERMINED THAT THE BID DOCUMENTS ARE ACCEPTABLE AND SUFFICIENT FOR BIDDING AND COMPLETING THE SERVICES; THAT BIDDER IS CAPABLE OF READING, FOLLOWING AND COMPLETING THE SERVICES IN ACCORDANCE WITH THE BID DOCUMENTS; AND THAT BIDDER AGREES THAT**

THE SERVICES CAN AND WILL BE COMPLETED ACCORDING TO THE DISTRICT'S TIMELINES.

10. Bidders Interested in More Than One Bid. No person, firm or corporation shall be allowed to make, or file, or be interested in more than one bid for the same services unless alternate bids are specifically called for by the District. A person, firm, or corporation that has submitted a bid to a bidder, or that has quoted prices of materials to a bidder, is not thereby disqualified from submitting a proposal or quoting prices to other bidders or submitting a bid.

11. Award of Contract. The District reserves the right to reject any or all bids, or to waive any irregularities or informalities in any bids or in the bidding process. The award of the contract, if made by the District, will be by action of the Governing Board and to the lowest responsive and responsible bidder or bidders by category (purchase amount and/or 9-month rental payment). The District will award to the bidder or bidders providing the lowest 9-monthly rental payment for new and/or used modular buildings, and the lowest bid amount purchase price for used and new buildings identified in the Bid Form Matrix. If two identical low bids are received from responsive and responsible bidders, the District will determine which bid will be accepted pursuant to Public Contract Code Section 20117. In the event an award of the contract is made to a bidder, and such bidder fails or refuses to execute the Agreement and provide the required documents within five (5) working days after the notice of award of the contract to bidder, the District may award the contract to the next lowest responsive and responsible bidder or reject all bidders.

12. Competency of Bidders. In selecting the lowest responsive and responsible bidder or bidders, consideration will be given not only to the financial standing but also to the general competency of the bidder for the performance of the services. By submitting a bid, each bidder agrees that the District, in determining the successful bidder and its eligibility for the award, may consider the bidder's experience and facilities, conduct and performance under other contracts, financial condition, reputation in the industry, and other factors which could affect the bidder's performance of the services. To this end, each bid shall be supported by a statement of the bidder's experience on the form entitled "INFORMATION REQUIRED OF BIDDER."

Operating costs, maintenance considerations, performance data and guarantees of materials and equipment may also be considered by the District. In this regard, the District may conduct such investigations as the District deems necessary to assist in the evaluation of any bid and to establish the responsibility, qualifications and financial ability of the bidder to perform the services to the District's satisfaction within the prescribed time. The District reserves the right to reject the bid of any bidder who does not pass any such evaluation to the satisfaction of the District.

13. License and Permits. If, at the time and date of the bid opening, bidder is not properly licensed to perform the services, such bid will be rejected as nonresponsive. Bidders, their employees, and agents shall secure and maintain valid permits and licenses that are required by all local, county, state, and federal laws for the execution of this contract.

14. Anti-Discrimination. In connection with all services performed under this bid, there shall be no unlawful discrimination against any prospective or active employee engaged in

the work because of race, color, ancestry, national origin, religious creed, sex, age, marital status, physical disability, mental disability, or medical condition. The successful bidder agrees to comply with applicable federal and state laws including, but not limited to, the California Fair Employment and Housing Act, beginning with Government Code Section 12900 and Labor Code Section 1735.

15. Hold Harmless and Indemnification. The successful bidder or bidders awarded the contract will be required to indemnify and hold harmless the District, its Governing Board, officers, agents, and employees as set forth in the Agreement.

16. Time is of the Essence. All services must be completed within the time limits set forth in the bid documents. It is agreed that failure to perform the services described herein within the time limits required will result in successful bidder being liable to the District, in an amount of cost plus 10% for each consecutive calendar day that services are not performed as required within the time limits required by the District. Such damages shall be deducted from any payments due or to become due to the successful bidder.

17. Bid Documents. The complete bid packet includes the following documents:

- Notice Calling for Bids
- Instructions for Bidders
- Information Required of Bidders
- Bid Form(s)/Bid Matrix Form(s)
- Non-collusion Declaration
- Worker's Compensation Certificate
- Drug-Free Workplace Certification
- Notice to Contractors Regarding Criminal Records Check
- Certification by Contractor Criminal Records Check
- Tobacco-Free Workplace Certification
- References

18. Drug-Free Workplace Certification. Pursuant to Government Code Sections 8350, et seq., the successful bidder will be required to execute a Drug-Free Workplace Certification upon execution of the Agreement. The bidder will be required to take positive measures outlined in the certification in order to ensure the presence of a drug-free workplace. Failure to abide with the conditions set forth in the Drug-Free Workplace Act could result in penalties including termination of the Agreement or suspension of payment thereunder.

19. Non-collusion Declaration. In accordance with the provisions of Section 7106 of the Public Contract Code, each bid must be accompanied by a non-collusion declaration.

20. Tobacco Use Policy Certification. The successful bidder shall agree to enforce a tobacco-free work site and will comply with the District's Tobacco Use Policy.

21. Criminal Records Check. The successful bidder will be required to comply with the applicable requirements of Education Code Section 45125.1 with respect to fingerprinting of employees and must complete the District's Criminal Records Check Certification.

22. Copies. The number of executed copies of the Agreement, required is three (3).

23. Term of Contract. – The term of this contract is for three (3) years.

24. Vehicles. – Successful bidder shall own, operate, and maintain one or more appropriate vehicles for the installation, delivery, return, and knockdown at such times and places as may be specified by the District.

25. Prices. – Pricing shall be inclusive of any and all cost charged to the District including incidental service charges for delivery, setup, dismantling and return, taxes and fuel surcharges as indicated in the Bid Matrix Form. The prices may be adjusted annually after the first year beginning in January, 2017. In the event the successful bidder proposed to increase or decrease the rates for the installation, delivery, return and knockdown services, the successful bidder shall provide the District with a written proposal on or before January 1 of each year. The price adjustment shall be calculated as follows: The original contract price, multiplied by the Office of Public School Construction Class B index, ending the month prior to the annual adjustment (i.e. December of the year immediately preceding the adjustment).

Freight/shipping charges that may be required by other agencies piggybacking off this contract are outside the scope of the base bid. Furthermore, additional charges due to site conditions or labor rates at other agencies piggybacking off his bid are also outside the scope of the base bid.

26. Independent Contractor. – While engaged in carrying out and complying with the terms and conditions of the contract, the successful bidder shall be deemed an independent contractor and not an officer, agent, or employee of the District.

27. Personnel. – All personnel assigned to perform under this contract shall be subject to continuous approval by the District at its discretion. All drivers shall be employees of the successful bidder and shall have proper licenses, permits and certificates as required by applicable statutory or administrative codes. Workers shall be neat in appearance, in good health and of the highest moral character. Workers shall be prohibited from smoking around students or on any District property. The District shall have the right to reject any worker and shall notify the successful bidder in writing.

28. Experience Factor. – Bidders are to have at least five (5) years of successful experience in providing services similar in size and scope to the requirements of this bid. All services are to be performed by trained and licensed personnel fully experienced in performing the services required.

29. Utilize Care Around Schools and Children. – Bidders acknowledge that the services to be performed under the contract may be done around schools and around children. Bidders shall advise all employees to use care, respect and discretion when working in these surroundings. All services must be coordinated and approved by District Project Manager prior to installation.

30. Insurance and Workers' Compensation. – Successful bidder shall obtain and maintain insurance coverage in the amounts set forth below during the term of the contract and shall furnish certificates of insurance for each policy to the District. The following coverage noted on the left with an “X” are required (Certificate or Endorsement) with the Minimum Limits as noted on the right.

<u>CERTIFICATE/ENDORSEMENTS</u>	<u>MINIMUM LIMITS PER OCCURRENCE</u>
<u> X / </u> Worker's Compensation	Statutory
<u> X / </u> Employer's Liability	\$1,000,000
() Broad Form–All States Endorsement	
(X) Other - Excess Liability	\$20,000,000 Each Occurrence
<u> X / X </u> Commercial General Liability	\$1,000,000 (\$2,000,000 Aggregate)
(X) Premises and Operations	() Explosion Hazard
(X) Contractual Liability	() Collapse Hazard
() Independent Bidders	() Underground Hazard
(X) Product/Completed Operations	() Garage Keepers Legal Liability
(X) Broad Form Property Damage	() Hanger Keepers Legal Liability
(X) Personal Injury	(X) Sexual Misconduct or Sexual Molestation Medical Expense Limit
(X) Broad Form Liability Endorsement	() Watercraft Liability
() Fire Legal Liability	
() Incidental Medical Malpractice	
<u> X / X </u> Vehicle (including auto) Liability <u>\$1,000,000</u> – combined single limit, each accident	
(X) Owned Vehicles	
(X) Non-owned Vehicles	
(X) Hired Vehicles	

For all insurance coverages provided by successful bidder, the following terms apply:

- A. All liability policies are to contain, or be endorsed to contain, the following provisions:
1. Successful bidder agrees to defend, indemnify, save and hold harmless the District, its Governing Board, officers, employees, agents, and representatives;
 2. Named additional insured endorsements for the District, its Governing Board, officers, employees, agents, and representatives. They are to be covered as insured as respects: liability arising out of activities performed by or on behalf of the successful bidder; products and completed operations of the successful bidder;

premises owned, occupied or used by the successful bidder; or automobiles owned, leased, hired or borrowed by the successful bidder. The coverage shall contain no special limitation on the scope of the protection afforded to the District, its Governing Board, officers, employees, agents, and representatives.

3. Each insurance policy required by this clause shall be endorsed to state that coverage shall not be suspended, voided, canceled by successful bidder, reduced in coverage or in limits except after thirty (30) days prior written notice by certified mail, return receipt requested, has been given to the District.
- B. The successful bidder agrees to purchase all required insurance at successful bidder's expense and to deposit with the District Certificates of Insurance, including all endorsements required herein, necessary to satisfy the District that the insurance provisions have been complied with and to keep such insurance coverage and the certificates therefore on deposit with the District during the entire term of the Agreement.
 - C. All insurance policies required by the Agreement shall declare any deductible or self-insured retention (SIR) in an amount in excess of \$25,000 (\$5,000 for automobile liability), which shall specifically be approved in writing by the District. Successful bidder shall be responsible for reimbursement of any deductible to the insurer. Any self-insured retentions (SIRs) or deductibles shall be clearly stated on the Certificate of Insurance.
 - D. The policy or policies of insurance must be issued by an insurer licensed to do business in the State of California (California Admitted Carrier). Minimum insurance company ratings as determined by the most current edition of the Best's Key Rating Guide/Property-Casualty/United States or ambest.com shall be A (Secure Best's Rating) and VIII (Financial Size Category). If the carrier is a non-admitted carrier in the state of California, District retains the right to approve or reject carrier after a review of the company's performance and financial ratings.
 - E. The District shall be added as an additional insured on all insurance policies with respect to services performed by the successful bidder (except Workers' Compensation/Employers' Liability). An additional insured endorsement evidencing that the District is an additional insured shall accompany the Certificate of Insurance. The successful bidder shall furnish the District with original endorsements effecting coverage required by this clause. The endorsements are to be signed by a person authorized by that insurer to bind coverage on its behalf. All endorsements are to be received and approved by the District before services commence.
 - F. All insurance policies required from the successful bidder shall be primary insurance, and any insurance maintained by the District shall be excess and non-contributing with insurance provided by these policies. An endorsement evidencing that the successful bidder's insurance is primary and non-contributing shall specifically accompany the Certificate of Insurance for the Commercial General Liability.
 - G. All insurance policies shall give the District thirty (30) days' notice in the event of

cancellation. This shall be evidenced by an endorsement separate from the Certificate of Insurance.

- H. All insurance policies and coverages shall waive all rights of subrogation against the District and members of the Governing Board, its officials, officers, and employees.
- I. If successful bidder's Professional Liability policy is a "claims made" policy, successful bidder shall agree to maintain professional liability coverage for two years following completion of the Agreement.
- J. The comprehensive General Liability policy shall contain a Severability of Interests clause.
- K. The successful bidder is aware of the provisions of Section 3700 of the California Labor Code which requires every employer to be insured against liability for Workers' Compensation or be self-insured in accordance with provisions of that code. The successful bidder will comply with such provisions and shall furnish the District satisfactory evidence that the successful bidder has secured, for the period of the Agreement, statutory Workers' Compensation insurance and Employer's Liability insurance with the required minimum limits per occurrence. The successful bidder who has been awarded the contract shall sign and file with District prior to performing the services, the Workers' Compensation Certificate included as a part of the bid documents. Labor Code section 1861.
- L. The procuring of such required policy or policies of insurance shall not be construed to limit successful bidder's liability hereunder nor to fulfill the indemnification provisions and requirements of the Agreement.

31. **PIGGYBACK: OTHER PUBLIC AGENCIES.** Pursuant to Public Contract Code Sections 20118 and 20652 and other applicable provisions, other public agencies, including school districts and community colleges in the State of California, may acquire items identified in this bid under the same terms and conditions of this bid. If so, the District waives its rights for a warrant to be drawn in its favor or for any reasonable costs, and directs each public agency to work directly with the successful bidder.

32. Fingerprint Certification/Criminal Records Check. – Successful bidder shall require each employee or driver in a position requiring contact with students to submit fingerprints consistent with California Education Code sections 33192, 44237. Successful bidder shall comply with the requirements of Education Code section 45125.1 including, but not limited to: obtaining California Department of Justice (CDOJ) clearance for successful bidder's employees and subcontractors, prohibiting its employees from coming in contact with students until CDOJ clearance is ascertained; and certifying in writing and proving such certification to the District that none of its employees and/or subcontractors who may come in contact with students have been convicted of or pleaded nolo contendere to a felony. Nor will any employee or subcontractor who has been convicted of or entered a plea of nolo contendere to charges of any sex offense as defined in Education Code section 44011, or to a felony that would disqualify that employee or driver pursuant to Education Code section 44237 be allowed to come in contact

with students. Successful bidder must complete Fingerprint Certification, contained in the bid documents.

35. **Questions and Addenda.** – Any and all questions regarding this bid must be submitted in writing to purchasing@ggusd.us before Thursday, May 26, 2016 at 5:00 PM. Answers to these questions and any other related addenda will be posted no later than 7:00 PM on Friday, May 27, 2016 on the District's website at: WWW.GGUSD.US.

BID FORM

Name of Bidder: _____
To: **Garden Grove Unified School District** acting by and through its Governing Board, herein called the "District."

1. The undersigned Bidder, having become familiarized with all the following documents including but not limited to the Notice Calling for Bids, Bid Objective, Information for Bidders, Bid Form including the Bid Form Matrix, Price Sheet, Information Required of Bidder, Non-collusion Declaration, Workers' Compensation Certificate, Agreement, Drug-Free Workplace Certification, Criminal Records Check Certification, Tobacco Use Policy Certification, all insurance requirements, General Conditions and Special Conditions, and all modifications, addenda and amendments, if any (hereinafter Bid Documents), the local conditions affecting the performance of the services and the cost of the services at the place where the services are to be performed, hereby proposes and agrees to be bound by all the terms and conditions of the Bid Documents and agrees to perform, within the time stipulated, the services, including all of its component parts, and everything required to be performed, and to provide and furnish and pay for any and all of the labor, materials, tools, expendable equipment, and all applicable taxes, necessary to perform the services and complete in a good workmanlike manner all of the services required in accordance with laws, codes, regulations, ordinances and any other legal requirements governing the services, in connection with the following:

DISTRICT-WIDE RENTAL AND/OR PURCHASE OF RELOCATABLE MODULAR BUILDINGS, Bid No. 1512

All in strict conformity with the Bid Documents, on file at the office of the Garden Grove Unified School District for the sums set forth in the Bid Form Price Sheet.

- District reserves the right to inspect and if necessary, refuse delivery of a purchased building based on the District's assessment of the buildings condition.
- HVAC units must be in good working order and must have a CRV.
- Contractor(s) shall have an assigned Account Representative available to the District during District working hours. The District prefers a single point of contact for ordering and/or other issues.
- Contractor shall offer repair work to be corrected within three (3) hours. All service response time shall be within twenty-four (24) hours on building rentals.
- All purchased building to be warrantied for one (1) year.
- Repair and warranty support shall be available to the District twenty-four (24) hours per day, seven (7) days per week.
- All on-site labor is subject to prevailing wage. District has ascertained the general prevailing rate of per diem wages in the locality in which this work is to be performed for each craft or type of worker is needed to execute this contract. These rates are on file at the District's office, and a copy may be obtained upon request. A copy of these rates shall be posted at the job site. The schedule of per diem wages is based upon a working day of eight hours.
- No cleaning fee upon return of modular classrooms to awarded vendor.
- All permits and permit fees shall be included in bid prices.

Pricing shall be inclusive of any and all cost charged to the District including incidental service charges for delivery, setup, dismantling and return, taxes and fuel surcharges as indicated in the Bid Matrix Form. The prices may be adjusted annually after the first year beginning in January, 2017. In the event the successful bidder proposed to increase or decrease the rates for the installation, delivery, return and knockdown services, the successful bidder shall provide the District with a written proposal on or before January 1 of each year. The price adjustment shall be calculated as follows: The original contract price, multiplied by the Office of Public School Construction Class B index, ending the month prior to the annual adjustment (i.e. December of the year immediately preceding the adjustment).

Freight/shipping charges that may be required by other agencies piggybacking off this contract are outside the scope of the base bid. Furthermore, additional charges due to site conditions or labor rates at other agencies piggybacking off his bid are also outside the scope of the base bid.

Each individual bid award shall be determined from reviewing all portions of the Bid Documents, and shall include all items necessary to complete the services, including the assumption of all obligations, duties, and responsibilities necessary to the successful completion of the services, and the furnishing of all materials and equipment required to be incorporated in and form a permanent part of the services, and the furnishing of tools, equipment, supplies, facilities, labor, and supervision, required to perform and complete the services, all as per the requirements of the Bid Documents, whether or not expressly listed or designated.

The District will award to the bidder or bidders providing the lowest 9-month rental payment for used and new modular buildings and the lowest bid amount purchase price for used and new modular buildings identified in the Bid Form Matrix.

2. District reserves the right to reject any or all bids or to waive any irregularities or informalities in any bids or in the bidding process. Bidder agrees that this bid shall remain open and not be withdrawn for the period specified in the Information for Bidders.

3. If written notice of the award of a contract is mailed, faxed, or delivered to the bidder, the bidder will execute and deliver to the District the Agreement and will also furnish and deliver to the District certificates and endorsements of insurance, the Workers' Compensation Certificate, Drug-Free Work Place Certification, the Criminal Records Check Certification, and Tobacco Use Policy Certification, within five (5) working days of the notice of award of the contract, or as otherwise requested in writing by the District.

4. Communications conveying notice of award of the contract, requests for additional information or other correspondence should be addressed to the bidder at the address stated below.

5. The name(s) of all persons interested in the bid as principals are as follows:

6. In submitting this bid, the bidder offers and agrees that if the bid is accepted, it will assign to District all rights, title and interest in and to all causes of action it may have under Section 4 of the Clayton Act (15 U.S.C. Section 15) or under the Cartwright Act (Business & Professions Code section 16700 et seq.) arising from purchases of goods, materials, or services by the bidder for sale to the District pursuant to the bid. Such assignment shall be made and become effective at the time the District tenders final payment under the contract. (Government Code section 4550 et seq.).

7. The undersigned hereby warrants that the bidder has all appropriate licenses at the time of the bid opening, that such license entitles bidder to provide the services, and that such license will be in full force and effect throughout the duration of performance of any awarded contract. Bidder shall be nonresponsive if the Bidder is not licensed as required by the Districts at the time of the bid opening.

8. The bidder hereby certifies that it is, and at all times during the performance of work hereunder shall be, in full compliance with the provisions of the Immigration Reform and Control Act of 1986 ("IRCA") in the hiring of its employees, and the bidder shall indemnify, hold harmless and defend the Districts against any and all actions, proceedings, penalties or claims arising out of the bidder's failure to comply strictly with the IRCA.

9. If requested by the Districts, the bidder shall furnish a notarized financial statement, references, and other information required by the District sufficiently comprehensive to permit an appraisal of bidder's ability to perform the awarded contract.

10. Time is of the essence.

11. The contract period will be for the period July 1, 2016 through June 30, 2019.

12. The required non-collusion declaration is attached as required by Public Contract Code Section 7106. Bidder understands and agrees that failure to submit a completed and signed declaration will render the bidder automatically nonresponsive.

13. The District reserves the right to award contract(s) by category to the lowest responsive and responsible bidder. Low bid for Rentals/Lease is based on a 9-month period.

14. Other districts in the State of California may procure items off this bid under the same terms and conditions stated in this bid (Ref. PCC 20118 – Said school district and public entities shall process their purchase orders and warrants directly to the successful bidder upon agreement by the District and the Contractor).

15. Contractor is fully aware of the registration requirements of the Department of Industrial Relations (DIR) and understands and agrees that any order may be subject to the registration requirements of the DIR. Any order may be canceled by the District if Contractor cannot establish to the District's satisfaction compliance with the requirements of the DIR.

16. Contractor agrees to comply with all applicable prevailing wage requirements determined by the DIR and shall maintain accurate payroll records available for inspection at all

times. DIR's Division of Labor Standards Enforcement shall monitor and enforce all prevailing wage compliance by the Contractor.

17. Bonding Capacity – Projects over \$25,000 require performance and payment bonds. Provide documentation from Bidder's surety identifying the following:

Name of bonding company/surety: _____

Name of surety agent: _____

Surety agent address: _____

Surety agent phone number: _____

Is surety a California-admitted surety? Yes ___ No ___

What is Bidder's total bonding capacity? _____

What percentage rate does the Bidder pay for bonds? _____

18. Attachments A through E and the Information Required of Bidder form have been fully completed and are attached hereto.

19. PIGGYBACK: OTHER PUBLIC AGENCIES. Pursuant to Public Contract Code Sections 20118 and 20652 and other applicable provisions, other public agencies, including school districts and community colleges in the State of California, may acquire items identified in this bid under the same terms and conditions of this bid. If so, the District waives its rights for a warrant to be drawn in its favor or for any reasonable costs, and directs each public agency to work directly with the successful bidder.

The undersigned hereby declares that all of the representations of this bid are made under penalty of perjury under the laws of the State of California.

Individual Name: _____
Signed by: _____
Print Name: _____
Date: _____
Business Address: _____

Telephone: _____

Partnership Name: _____
Signed by: _____
Print Name: _____
Date: _____
Business Address: _____

Telephone: _____
Other Partner(s): _____

Corporation Name: _____
(a _____ Corporation¹)
Business Address: _____

Telephone: _____
Signed by: _____, President, Date: _____
Print Name: _____, President
Signed by: _____, Secretary, Date: _____
Print Name: _____, Secretary
[Seal]

¹ A corporation awarded the contract shall furnish evidence of its corporate existence and evidence that the officer signing the Agreement and bonds is duly authorized to do so.

Joint Venture:

Name: _____

Signed by: _____, Joint Venture

Print Name: _____

Date: _____

Business Address: _____

Telephone: _____

Other Parties to
Joint Venture:

If an individual: _____
(Name)

Signed by: _____

Print Name: _____

Date: _____

Doing Business as: _____;

Business Address: _____

Telephone: _____

If a Partnership: _____
(Name)

Signed by: _____, Partner

Print Name: _____

Date: _____

Business Address: _____

Telephone: _____

If a Corporation: _____
(a _____ Corporation)

Signed By: _____ Date: _____

Print Name: _____

Title: _____

Date: _____

Business Address: _____

Telephone: _____

BID FORM MATRIX – ATTACHMENTS A - E

GARDEN GROVE UNIFIED SCHOOL DISTRICT BID NO. 1512

	ADDITIVE ALTERNATIVES	UNIT	PRICE
	FLOORING		
1	STANDARD CARPET	SQUARE FOOT	
2	NON STANDARD CARPET 26 OZ OLEFIN	SQUARE FOOT	
3	UPGRADE STANDARD CARPET - LEES FACULTY 4	SQUARE FOOT	
4	UPGRADE STANDARD CARPET - COLLINS/AIKMAN	SQUARE FOOT	
5	CERAMIC TILE WITH THIN SET BASE OVER 1 1/2' BACKING	SQUARE FOOT	
6	VCT	SQUARE FOOT	
7	CARPET TILE 2'X2'	SQUARE FOOT	
8	FLAT LAY SHEET VINYL	SQUARE FOOT	
9	SHEET VINYL WITH SELF COVE	SQUARE FOOT	
10	VINYL UPGRADE OF FORBO MARMOLEUM	SQUARE FOOT	
11	KITCHEN SHOWER AREA ALTRA MARINE SAFETY FLOOR	SQUARE FOOT	
12	EPOXY BUILT UP FLOOR AND WALL COATING	SQUARE FOOT	
	WALLS		
13	INTERIOR NON-RATED 2X4 WALL, 16"OC FLOOR TO RAFTER	LINEAR FOOT	
14	INTERIOR NON-RATED 2X4 WALL, 16"OC FLOOR TO CEILING	LINEAR FOOT	
15	R19 INSULATION IN LIEU OF R-11	SQUARE FOOT	
16	2x6 EXTERIOR WALL WITH R19 INSULATION	LINEAR FOOT	
17	INTERIOR 1 HOUR FIRE RATED WALL, 16"OC FLOOR TO RAFTERS	LINEAR FOOT	
18	INTERIOR 2 HOUR FIRE RATED WALL, 16"OC FLOOR TO RAFTERS	LINEAR FOOT	
19	EXTERIOR 1 HOUR FIRE RATED WALL	LINEAR FOOT	
20	EXTERIOR 2 HOUR FIRE RATED WALL	LINEAR FOOT	
21	TAPE TEXTURE AND PAINT IN LIEU OF VINYL COVERED TACK BOARD	SQUARE FOOT	
22	STAINLESS STEEL WALL COVERING	SQUARE FOOT	
23	FIBER GLASS WALL PANELS (3/32 FRP) IN LIEU OF VCT	SQUARE FOOT	
24	OPERABLE WALL 24'	EACH	
25	OPERABLE WALL 36'	EACH	
26	CERAMIC TILE WALL	SQUARE FOOT	
27	WALL VINYL UPGRADE	SQUARE FOOT	
28	24 GAUGE WHITE MAGNETIC MARKER BOARD (4X8)	EACH	
	ROOF		
29	HARD CEILINGS	SQUARE FOOT	
30	1 HOUR FIRE RATED CEILINGS	SQUARE FOOT	
31	2 HOUR FIRE RATED CEILINGS	SQUARE FOOT	
32	VINYL COVERED GYPSUM CEILING PANELS IN COMMERCIAL KITCHEN	SQUARE FOOT	
33	POLYISOCYANURATE ROOF INSUALTION R-19	SQUARE FOOT	
34	POLYISOCYANURATE ROOF INSUALTION R-30	SQUARE FOOT	
35	COMPOSITION SHINGLE ROOF	SQUARE FOOT	
36	GEO FLEX ROOF SYSTEM	SQUARE FOOT	
37	BUILT UP ROOF SYSTEM	SQUARE FOOT	
38	TPO ROOF SYSTEM	SQUARE FOOT	
39	EPDM ROOF SYSTEM	SQUARE FOOT	
40	R-30 MFIBERGLASS INSULATION IN LIEU OF R-18	SQUARE FOOT	
41	MANSARD - METAL	LINEAR FOOT	
42	MANSARD - TILE	LINEAR FOOT	
43	MANSARD - COMPOSITION SHINGLE	LINEAR FOOT	
44	42" PARAPET	LINEAR FOOT	
45	30" FASCIA METAL	LINEAR FOOT	
46	30" FASCIA STUCCO	LINEAR FOOT	
47	BOX SOFFIT STUCCO	LINEAR FOOT	
48	BOX SOFFIT DURATEMP OR T1-11 SIDING	LINEAR FOOT	
49	2X2 SKYLIGHT WITH LIGHT SHAFT	EACH	
50	2X4 SKYLIGHT WITH LIGHT SHAFT	EACH	

GARDEN GROVE UNIFIED SCHOOL DISTRICT BID NO. 1512

51	4X4 SKYLIGHT WITH LIGHT SHAFT	EACH	
	ADDITIVE ALTERNATIVES		
	DOORS		
52	EXTERIOR DOOR PACKAGE - STEEL 3070	EACH	
53	UPGRADE TO WELDED DOOR FRAME	EACH	
54	SINGLE STOREFRONT GLASS DOOR	EACH	
55	DOUBLE STOREFRONT GLASS DOOR	EACH	
56	1 HR FIRE RATED DOOR	EACH	
57	SIDE LIGHT HOLLOW METAL FRAME WINDOW	EACH	
58	DOUBLE DOOR SIDE LITE	EACH	
59	EXTERIOR DOOR WITH 2" SIDELIGHT	EACH	
60	EXTERIOR DOOR WITH 5" SIDELIGHT	EACH	
61	TRANSFORM TOP DOOR HOLLOW METAL FRAME WINDOW	EACH	
62	INTERIOR DOOR PACKAGE - WOOD	EACH	
63	ROLLUP OVERHEAD DOOR 10X8	EACH	
64	ROLLUP OVERHEAD DOOR 16X9 MOTORIZED 1 HR RATED	EACH	
65	FLOOR ACCESSORIES HATCH 24 X 24	EACH	
66	ROOF HATCH 36X36	EACH	
67	PANIC HARDWARE IN LIEU OF STANDARD LOCKSET	EACH	
68	SCHLAGE VANDAL GUARD OR EQUAL IN LIEU OF STANDARD	EACH	
69	HARDWARE UPGRADE "A"	EACH	
70	HARDWARE UPGRADE "B"	EACH	
71	HARDWARE UPGRADE "C"	EACH	
	WINDOWS		
72	8040 XOX /DG SLIDING ALUMINUM WINDOW 46%	EACH	
73	6040 XOX /DG SLIDING ALUMINUM WINDOW 46%	EACH	
74	4042 XOX /DG SLIDING ALUMINUM WINDOW 46%	EACH	
75	8040 XOX HOLLOW METAL WINDOW	EACH	
76	6040 XOX HOLLOW METAL WINDOW	EACH	
77	4040 XOX HOLLOW METAL WINDOW	EACH	
78	8020 XOX HOLLOW METAL WINDOW	EACH	
79	6020 XOX HOLLOW METAL WINDOW	EACH	
80	4020 XOX HOLLOW METAL WINDOW	EACH	
81	4040 FIXED INTERIOR WINDOW	EACH	
82	UPGRADE TO LOW E GLAZING	SQUARE FOOT	
83	UPGRADE TO LEXAN GLASS	SQUARE FOOT	
84	SECURITY SCREENS	SQUARE FOOT	
85	FIRE RATED WINDOWS	SQUARE FOOT	
86	1" INSET METAL BLINDS ON EXTERIOR WINDOWS	SQUARE FOOT	
	ELECTRICAL		
87	150 AMP SINGLE PHASE PANEL	EACH	
88	200 AMP SINGLE PHASE PANEL	EACH	
89	400 AMP SINGLE PHASE PANEL	EACH	
90	100 AMP THREE PHASE PANEL	EACH	
91	150 AMP THREE PHASE PANEL	EACH	
92	200 AMP THREE PHASE PANEL	EACH	
93	225 AMP THREE PHASE PANEL	EACH	
94	400 AMP THREE PHASE PANEL	EACH	
95	6X6X6 EXTERIOR SIGNAL BOX A/3/4" CONDUIT TO ATTIC	EACH	
96	12X12X6 EMPTY BOX	EACH	
97	3 COMPARTMENT EMPTY GUTTER TRAY	EACH	
98	4 COMPARTMENT EMPTY GUTTER TRAY	EACH	
99	110V DUPLEX WALL RECEPTABLE WITH COVER	EACH	
100	110V DUPLEX WALL RECEPTABLE WITH COVER - DEDICATED	EACH	

GARDEN GROVE UNIFIED SCHOOL DISTRICT BID NO. 1512

101	110V DUPLEX WALL GFI RECEPTABLE WITH COVER	EACH	
102	110V DUPLEX FLOOR RECEPTABLE WITH COVER	EACH	
103	110V FOUR PLEX FLOOR BOX	EACH	
104	DATA FLOOR BOX	EACH	
105	220V DUPLEX WALL RECEPTABLE WITH COVER	EACH	
106	30 AMP CIRCUIT - WALL	EACH	
107	40 AMP CIRCUIT - WALL	EACH	
108	50 AMP CIRCUIT - WALL	EACH	
109	60 AMP CIRCUIT - WALL	EACH	
110	DEDICATED FOUR PLEX WALL RECEIPT	EACH	
111	WIRE MOLD SERIES 5500	LINEAR FOOT	
112	DATA WALL BOX WITH BLANK COVER PLATE	EACH	
113	INTERIOR LIGHT SWITCH	EACH	
114	INTERIOR LIGHT SWITCH - THREE WAY	EACH	
115	INTERIOR 2X4 FLUORESCENT FIXTURE W/A+LOW HARMONIC BALLAST	EACH	
116	INTERIOR 2X4 FLUORESCENT FIXTURE WITH BATTERY BACKUP	EACH	
117	UPGRADE INT. 2X4 FLUOR. FIXTURE TO T-8 LAMPS	EACH	
118	INTERIOR 2X4 FLUORESCENT FIXTURE WITH T-8 LAMPS	EACH	
119	INTERIOR 2X2 FLUORESCENT FIXTURE WITH T-8 LAMPS	EACH	
120	EMERGENCY LIGHT W/ BATTERY BACKUP-INTERIOR WALL MOUNT	EACH	
121	EXIT LIGHT W/BATTERY BACKUP - INTERIOR WALL MOUNT (HIGH)	EACH	
122	EXTERIOR FLUORESCENT FIXTURE WITH INTEGRAL PHOTO CELL	EACH	
123	70W HPS EXTERIOR LIGHTING	EACH	
124	ELECTRIC HAND DRYER	EACH	
125	TV BRACKET WITH BACKING	EACH	
126	FIRE ALARM SYSTEM BLDG SF	SQUARE FOOT	
127	SMOKE/HEAT DETECTOR	EACH	
128	CO2 DETECTOR FIRE SPRINKLER IN OPEN BLDG BY SF	EACH	
129	FIRE SPRINKLER IN OPEN BLDG BY SF	SQUARE FOOT	
130	ABC RATED WALL HUNG FIRE EXTINGUISHER	EACH	
131	ABE RATED FIRE EXTINGUISHER IN SEMI RECESSED WALL CABINET	EACH	
	HEATING AND COOLING		
132	UPGRADE FROM 3.5 FT WALL MT HEAT PUMP TO 4T WALL MT HEAT PUMP	EACH	
133	UPGRADE FROM 3.5 FT WALL MT HEAT PUMP TO 5T WALL MT HEAT PUMP	EACH	
134	UPGRADE FROM 3.5 FT WALL MT HEAT PUMP TO 3.5FT ROOF MT HEAT PUMP	EACH	
135	UPGRADE FROM 3.5 FT WALL MT HEAT PUMP TO 4T ROOF MT HEAT PUMP	EACH	
136	UPGRADE FROM 3.5 FT WALL MT HEAT PUMP TO 5T ROOF MT HEAT PUMP	EACH	
137	UPGRADE FROM 3.5 FT WALL MT HEAT PUMP TO 3.5T INTERIOR HEAT PUMP	EACH	
138	UPGRADE FROM 3.5 FT WALL MT HEAT PUMP TO 4T INTERIOR HEAT PUMP	EACH	
139	UPGRADE FROM 3.5 FT WALL MT HEAT PUMP TO 5T INTERIOR HEAT PUMP	EACH	
140	ADD 2 TON WALL MOUNT HEAT PUMP UNIT	EACH	
141	ADD 3.5 TON WALL MOUNT HEAT PUMP UNIT	EACH	
142	ADD 4 TON WALL MOUNT HEAT PUMP UNIT	EACH	
143	ADD 5 TON WALL MOUNT HEAT PUMP UNIT	EACH	
144	ADD 3.5T ROOF MOUNT HEAT PUMP UNIT	EACH	
145	ADD 4T ROOF MOUNT HEAT PUMP UNIT	EACH	
146	ADD 5T ROOF MOUNT HEAT PUMP UNIT	EACH	
147	ADD 3.5T ROOF MOUNT GAS PACK UNIT	EACH	
148	ADD 4T ROOF MOUNT GAS PACK UNIT	EACH	
149	ADD 5T ROOF MOUNT GAS PACK UNIT	EACH	
150	ADD 7T ROOF MOUNT GAS PACK UNIT	EACH	
151	ADD 10T ROOF MOUNT GAS PACK UNIT	EACH	
152	ADD 3.5T INTERIOR HEAT PUMP UNIT	EACH	
153	ADD 4T INTERIOR HEAT PUMP UNIT	EACH	

GARDEN GROVE UNIFIED SCHOOL DISTRICT BID NO. 1512

154	ADD 5T INTERIOR HEAT PUMP UNIT	EACH
155	WAG 40 GAS HVAC UNIT IN LIEU PF 3-1/2 TON WALL MOUNT HEAT PUMP	EACH
156	RESTROOM CEILING HEATER	EACH
	ADDITIVE ITEMS	
157	PER UNIT 3PHS UPGRADE	EACH
158	PER UNIT BARD UPGRADE	EACH
159	12 SEER UPGRADE	EACH
160	AIR PURIFIER	EACH
161	SUPPLY REGISTER AND 12' OF FLEX DUCT	EACH
162	RETURN AIR REGISTER AND 12' OF FLEX DUCT	EACH
163	ADD FLEX DUCTING BY LF	LINEAR FOOT
164	ADD GALVANIZED DUCTING BY LF	LINEAR FOOT
165	SMOKE/FIRE DAMPERS	EACH
166	BAROMETRIC RELEIF DAMPER	EACH
167	HVAC RETURN AIR PLENUM CHASE WALL (12 FEET)	EACH
168	FIRE RATED SHAFT	LINEAR FOOT
169	CEILING EXHAUST FAN (120 CFM) WITH DUCT	EACH
170	KITCHEN EXHAUST FAN, COOK VCR-XP-300 2750 CFM	EACH
171	KITCHEN EXHAUST FAN, COOK VCR-XP-300 2050 CFM	EACH
172	KITCHEN SUPPLY FAN, COOK 120KSP-B-220 CFM	EACH
173	EXHAUST FAN COOK ACEB 702C2B	EACH
174	EXHAUST FAN COOK ACEB 602C2B	EACH
175	INSECT CONTROL FAN	EACH
176	FUME HOOD (6FT)	EACH
	PLUMBING	EACH
177	INTERIOR UNISEX TOILET ROOM	EACH
178	INTERIOR PRIMARY UNISEX TOILET	EACH
179	INSTANT FLOW ELECTRIC TANKLESS WATER HEATER	EACH
180	6 GAL ELECTRIC WATER HEATER	EACH
181	10 GAL ELECTRIC WATER HEATER	EACH
182	50 GAL ELECTRIC WATER HEATER	EACH
183	GAS PIPING	LINEAR FOOT
184	GAS TURRETS	EACH
185	CAST IRON DRAIN LINES	LINEAR FOOT
186	ACID RESISTANT WASTE PIPING	LINEAR FOOT
187	FLOOR DRAINS	EACH
188	NON FREEZE PROOF HOSE BIB WITH PLUMBERS KEY	EACH
189	PLUMB WALL FOR FIXTURE WITH SUPPLY LINE(S) AND DRAIN LINES	EACH
190	ADA DRINKING FOUNTAIN DUAL WALL MOUNTED INTERIOR	EACH
191	ADA DRINKING FOUNTAIN DUAL WALL MOUNTED EXTERIOR	EACH
192	ADA BUBBLER FOR SINK	EACH
193	LAVATORY WALL HUNG VITREOUS CHINA 19"X17" WITH ACRIERS	EACH
194	TOILET WALL HUNG VITREOUS CHINA FLUSH VALVE ADA / STANDARD	EACH
195	FLUSH VALVE TOILET OR URINAL	EACH
196	15X22 COFFEE BAR SINK W/GOOSE NECK FAUCET & WRIST BLADE HANDLES	EACH
197	CLASSROOM 17X25 SINK	EACH
198	BRADLEY SINK SS-2	EACH
199	BRADLEY SINK MG-2	EACH
200	BRADLEY SINK AND COUNTER 72"	EACH
201	DOUBLE BOWL STAINLESS STEEL WITH 8" SINGLE LEVER FAUCET	EACH
202	THREE BOWL 55 COMM SINK INCLUDES DRAIN BOARDS AND FAUCET	EACH
203	MOP SINK FGLASS W/LEGS AND SWING FAUCET	EACH
204	MOP SINK 24X24" FLOOR MOUNTED WITH WALL FAUCET	EACH
205	36"X36" FIBERGLASS ADA SHOWER UNIT WITH FLOOR DRAIN	EACH

GARDEN GROVE UNIFIED SCHOOL DISTRICT BID NO. 1512

206	FIBERGLASS ADA SHOWER STALL WITH ADA LIP AND SEAT	EACH	
207	IN SINK GARBAGE DISPOSAL	EACH	
208	EMERGENCY EYE WASH	EACH	
209	MIRROR, TOILET PAPER, PAPER TOWEL, SOAP, TOILET SEAT COVER DISP (MUST MEET ADA)	EACH	
210	SOLID PLASTIC PARTITIONS UPGRADE	LINEAR FOOT	
	CABINERY		
211	ADA PLUMBED SINK AND CABINET W/BUBBLER	EACH	
212	BASE CABINET - WIC #102 L36XH36XD24	EACH	
213	BASE CAB WIC #142	EACH	
214	DRAWER BASE CAN WIC #222	EACH	
215	DRAWER BASE CAN WIC #240	EACH	
216	DRAWER BASE CAN WIC #230	EACH	
217	WALL HUNG CAB WIC #312	EACH	
218	OPEN UPPER CABINET - WIC #300 L36 X H30 X D12	EACH	
219	UPPER CABINET WITH DOORS - WIC #400 L36 X H84 X D24	EACH	
220	OPEN TALL STORAGE CABINET - WIC #402 L36 X H84 X D24	EACH	
221	LOCKABLE TALL STORAGE UNIT CABINET - WIC #402 L36 X H84 X D24	EACH	
222	TALL STORAGE WIC #440	EACH	
223	7" CORNER TV CABINET	EACH	
224	TALL TEACHER CABINET WIC #530 L48 X H84 X D24	EACH	
225	16' TEACHING WALL	EACH	
226	30' TEACHERS WALL	EACH	
227	30' SPECIAL TECH WALL	EACH	
228	SCIENCE WORK STATION/ISLAND	EACH	
229	KITCHEN	EACH	
230	WARDROBE RACK WIC #540 L60 WITH 15 HOOKS (INTERIOR)	EACH	
231	WARDROBE RACK WIC #540 L60 WITH 15 HOOKS (EXTERIOR)	EACH	
232	CUBBY STORAGE WIC #544 L48 X H66 X D12 (48 CUBICLES)	EACH	
233	LOW BOOK SHELVES - WIC #600 L36 X H42 X D9	EACH	
234	HIGH PRESSURE LAMINATE COUNTER TOP	LINEAR FOOT	
235	EPOXY COUNTER TOP	LINEAR FOOT	
236	CABINET BLOCKING - UPPER 4X4	LINEAR FOOT	
237	CABINET BLOCKING - LOWER	LINEAR FOOT	
	LOCKERS AND BENCHES		
238	SINGLE TIER STANDARD LOCKER: 15"W x 72"H x 18"D (16 GAUGE STEEL)	EACH	
239	DOUBLE TIER STANDARD LOCKER: 15"W x 36"H x 18"D (16 GAUGE STEEL)	EACH	
240	TRIPLE TIER STANDARD LOCKERS: 15"W x 24"H x 18"D (16 GAUGE STEEL)	EACH	
241	SIX TIER BOX LOCKERS: 12"W x 12"H x 15"D (16 GAUGE STEEL)	EACH	
242	STANDARD GEAR LOCKER: 24"W x 72"H x 24"D (16 GAUGE STEEL)	EACH	
243	BENCH: 48"W x 18"H x 9.5"D (ALUMINUM OR WOOD)	EACH	
244	BENCH: 72"W x 18"H x 9.5"D (ALUMINUM OR WOOD)	EACH	
245	BENCH: 96"W x 18"H x 9.5"D (ALUMINUM OR WOOD)	EACH	
	APPLIANCES		
246	RESIDENTIAL RANGE HOOD	EACH	
247	RESIDENTIAL FREE STANDING 30" ELECTRIC RANGE	EACH	
248	RESIDENTIAL REFRIGERATOR (18 CU FT) FROST-FREE	EACH	
249	24" UNDER COUNTER RESIDENTIAL REFRIGERATOR 6.0 CU FT	EACH	
250	RESIDENTIAL DISHWASHER (2 CYCLE)	EACH	
251	RESIDENTIAL WASHER	EACH	
252	RESIDENTIAL DRYER	EACH	
253	COMM RANGE HOOD 5 X 21 WITH FIRE SUPPRESSION SYSTEM	EACH	
254	VULCAN 36L COMMERCIAL 6 BURNER RANGE WITH OVEN	EACH	
255	SINGLE DOOR 27" COMM FREEZER 23 CU FT	EACH	
256	SINGLE DOOR 27" COMM REFER 23 CU FT	EACH	

GARDEN GROVE UNIFIED SCHOOL DISTRICT BID NO. 1512

257	COMMERCIAL DISHWASHER	EACH	
258	8 X 8 WALK IN REFRIGERATOR	EACH	
259	12 X 17 WALK IN REFRIGERATOR	EACH	
260	10 X 20 WALK IN FREEZER	EACH	
261	DISPOSER 1-1/2 HP	EACH	
262	FAUCET PRE-RINSE	EACH	
263	SINK-FOOD PREP 1 COMPARTMENT	EACH	
	MISC ITEMS		
264	ADDITIONAL METAL 4 X 11 RAMP AND 5 X 7 LANDING WITH HANDRAILS (RAMP A)	EACH	
265	SWITCH BACK RAMP (RAMP B)	EACH	
266	OFFSET RAMP (RAMP C)	EACH	
267	COMMON DECK WITH RAMP (RAMP D)	EACH	
268	ADD A METAL LANDING AND 3 STEP RISER WITH HANDRAILS (STEP)	EACH	
269	RAMP EXTENSION - EXTEND METAL RAMP WITH HANDRAILS ATTACHED TO BUILDING	LINEAR FOOT	
270	RAMP EXTENSION - EXTEND METAL RAMP WITH HANDRAILS OFFSET FROM BUILDING	LINEAR FOOT	
271	CONCRETE 4 X 11 RAMP AND 5 X 7 LANDING WITH HANDRAILS	EACH	
272	EXTEND CONCRETE RAMP OR LANDING WITH HANDRAILS	LINEAR FOOT	
273	TMP BELOW 30" - STEEL RAMP	SQUARE FOOT	
274	TMP BELOW 30" - GALVANIZED/ALUMINUM RAMP	SQUARE FOOT	
275	TMP BELOW 30" - ALUMINUM RAMP	SQUARE FOOT	
276	TMP ABOVE 30" - STEEL RAMP	SQUARE FOOT	
277	TMP ABOVE 30" - GALVANIZED/ALUMINUM RAMP	SQUARE FOOT	
278	TMP ABOVE 30" - ALUMINUM RAMP	SQUARE FOOT	
279	EXTERIOR PLASTER STUCCO (3 COAT)	SQUARE FOOT	
280	FORKLIFT	PER DAY	
281	GUTTER/DOWNSPOUTS	LINEAR FOOT	
282	ADD FOR ENERGY AND ENVIRONMENT BUILDING PACKAGE	SQUARE FOOT	
283	ENGINEERING AND DESIGN	PER HOUR	
284	CONTRACT AND PROJECT SUPERVISION	PER HOUR	
285	UNFORSEEN ITEMS NOT ITEMIZED WILL BE INVOICED TO INCLUDE % SUPERVISION AND % OVERHEAD AND PROFIT.	PERCENT	
286	DSA MEETING TRIP COST	FEE	
287	ANY ITEM HEREIN NOT STATED WILL BE AT COST AND MARK UP	PERCENT	
288	DUMPSTER (40FT ROLL OFF) PER ROLL OFF/LOAD	PER LOAD	
289	TEMPORARY TOILET W/HAND WASH	PER WEEK	
290	UNION RATE - PREVAILING WAGE LABOR PER HOUR (MINIMUM 4 HRS)	PER HOUR	
291	STANDARD - PREVAILING WAGE LABOR PER HOUR (MINIMUM 4 HRS)	PER HOUR	
292	DAILY CREW PER DIEM OUTSIDE 150 MILES	PER DAY	
	ADDITIVE ALTERNATIVE DELIVERY SERVICE CALL TRANS APPROVED ROUTES RATES FOR UP TO 40' MODULE	LOCATION	
	MILES		
293	0-50	EACH	
294	51-75	EACH	
295	76-100	EACH	
296	101-125	EACH	
297	126-150	EACH	
298	151-175	EACH	
299	176-200	EACH	
300	201-225	EACH	
301	226-250	EACH	
302	251-275	EACH	
303	275-300	EACH	
304	301-325	EACH	
305	326-350	EACH	

GARDEN GROVE UNIFIED SCHOOL DISTRICT BID NO. 1512

306	351-375	EACH	
307	376-400	EACH	
308	401-425	EACH	
309	ADD 60' MODULAR/OVERSIZE 12'+	EACH	
310	PILOT CAR PER MILE PER PILOT CAR	EACH	
311	POLE CAR PER MILE	EACH	
	ADDITIVE ALTERNATIVE - RELOCATION SERVICES		
312	12 X 40 BUILDING RELOCATION	EACH	
313	24 X 40 BUILDING RELOCATION	EACH	
314	ADDITIONAL 12 X 40 MODULES RELOCATION	EACH	
315	30 X 32 BUILDING BUILDING RELOCATION	EACH	
316	ADDITIONAL 10 X 32 MODULES RELOCATION	EACH	
317	24 X 60 BUILDING RELOCATION	EACH	
318	ADDITIONAL 12 X 60 MODULES RELOCATION	EACH	
319	SIDE LOADS	EACH	
320	REVERSE LOADS	EACH	
321	3 POINT UNLOADS	EACH	
322	MODULE SHUTTLE SERVICE AT SITE PER MODULE	EACH	
323	CRANING AND RIGGING (4 HOUR MINIMUM) - PER HOUR	EACH	
324	2' WOOD CLOSE OFF BETWEEN BUILDINGS (DETAIL 1)	EACH	
325	5' WOOD CLOSE OFF BETWEEN BUILDINGS (DETAIL 1)	EACH	
326	6" EXPANDED METAL CLOSE OFF BETWEEN BUILDINGS AT ROOF (DETAIL 2)	LINEAR FOOT	
327	6" EXPANDED METAL CLOSE OFF BETWEEN BUILDINGS AT SURFACE (DETAIL 3)	EACH	

DRAWINGS

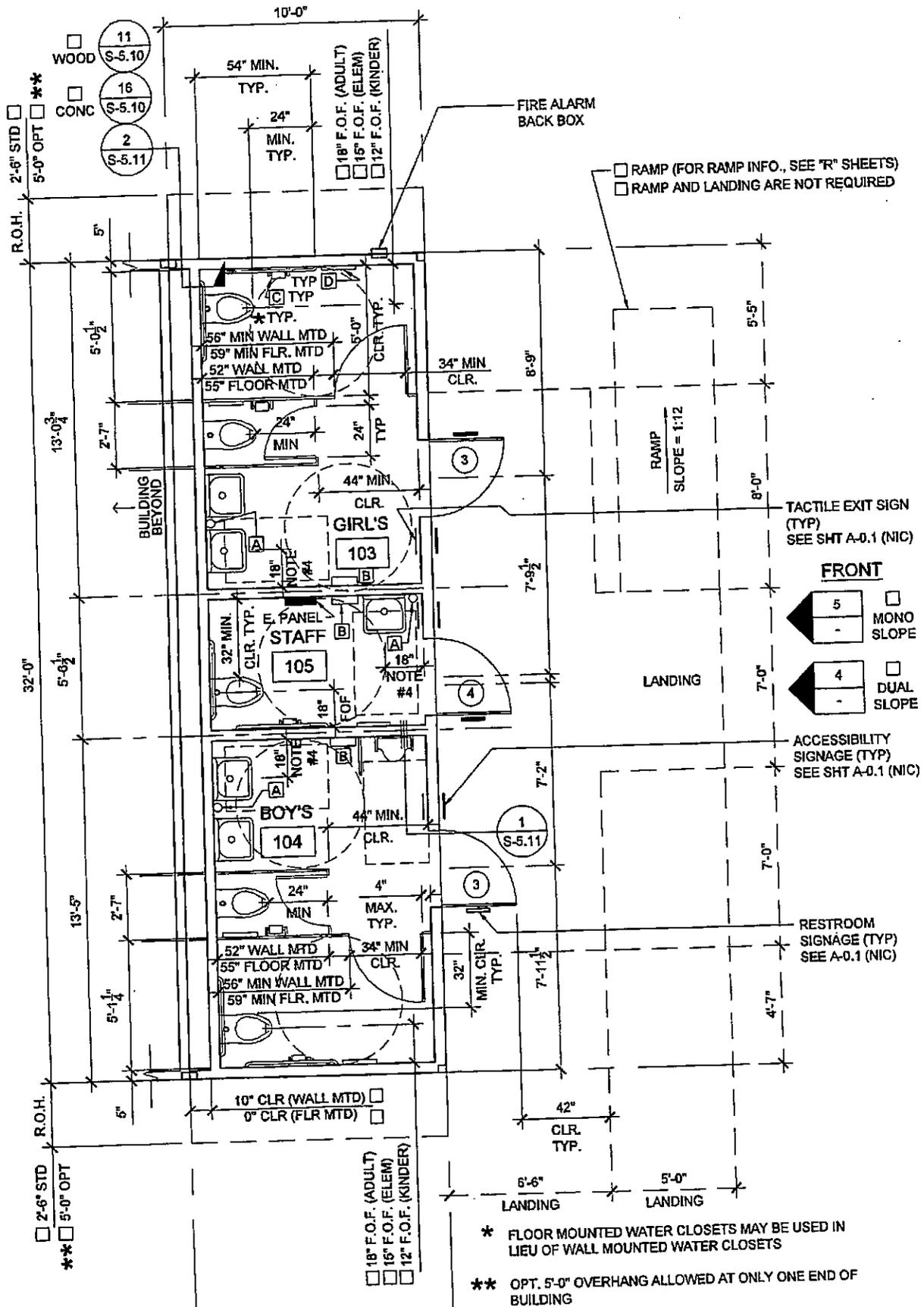

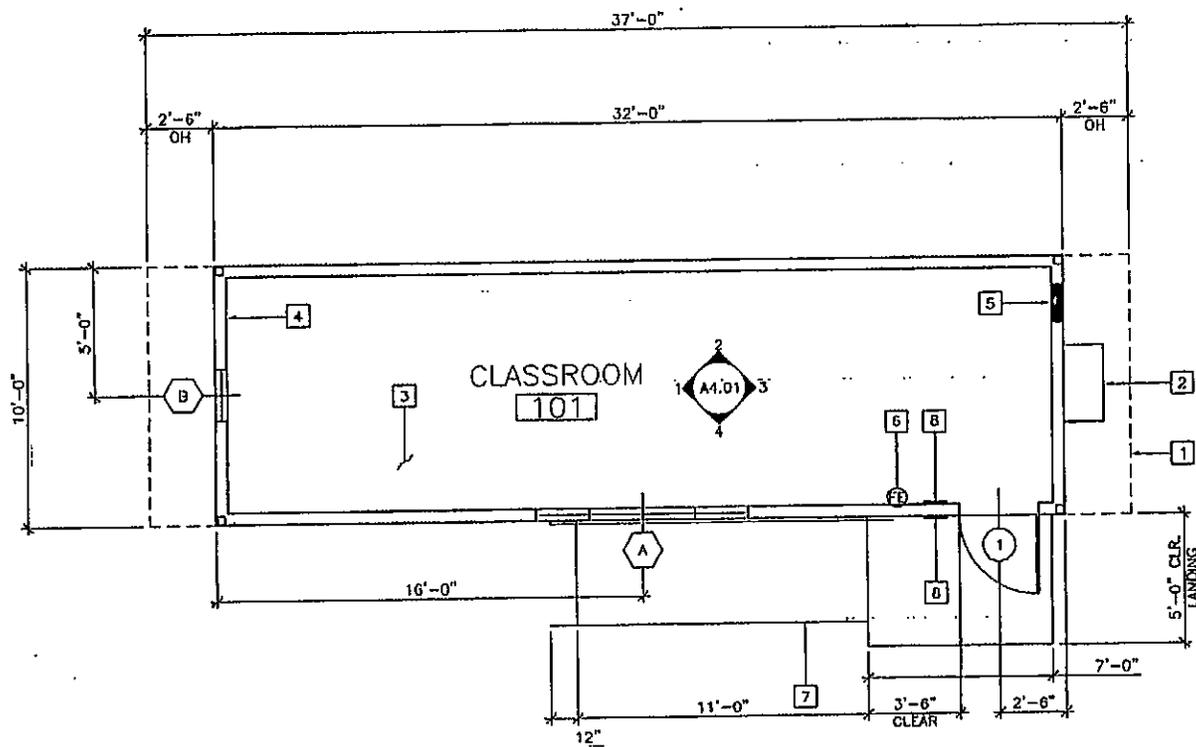

A-2

A3

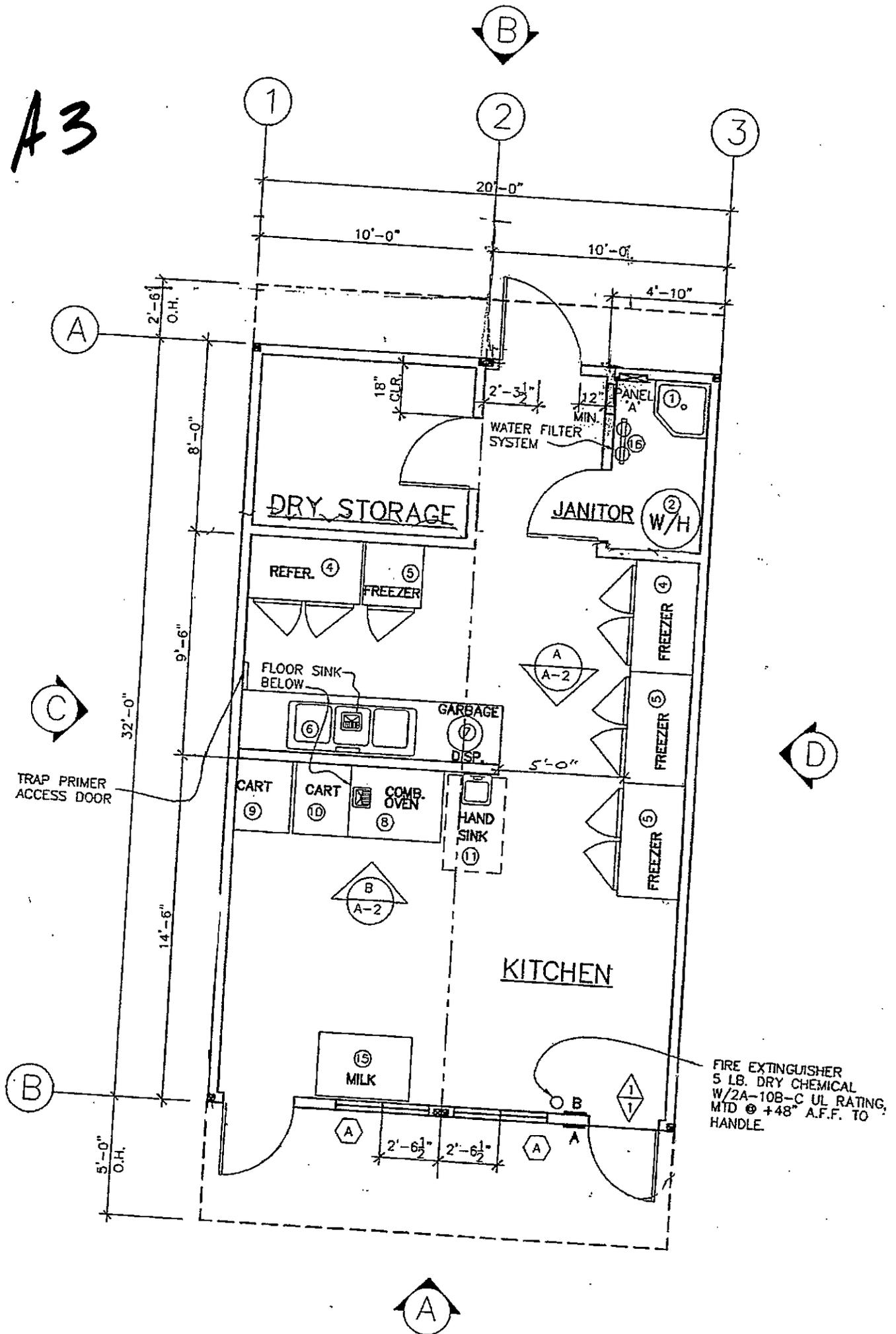

A4

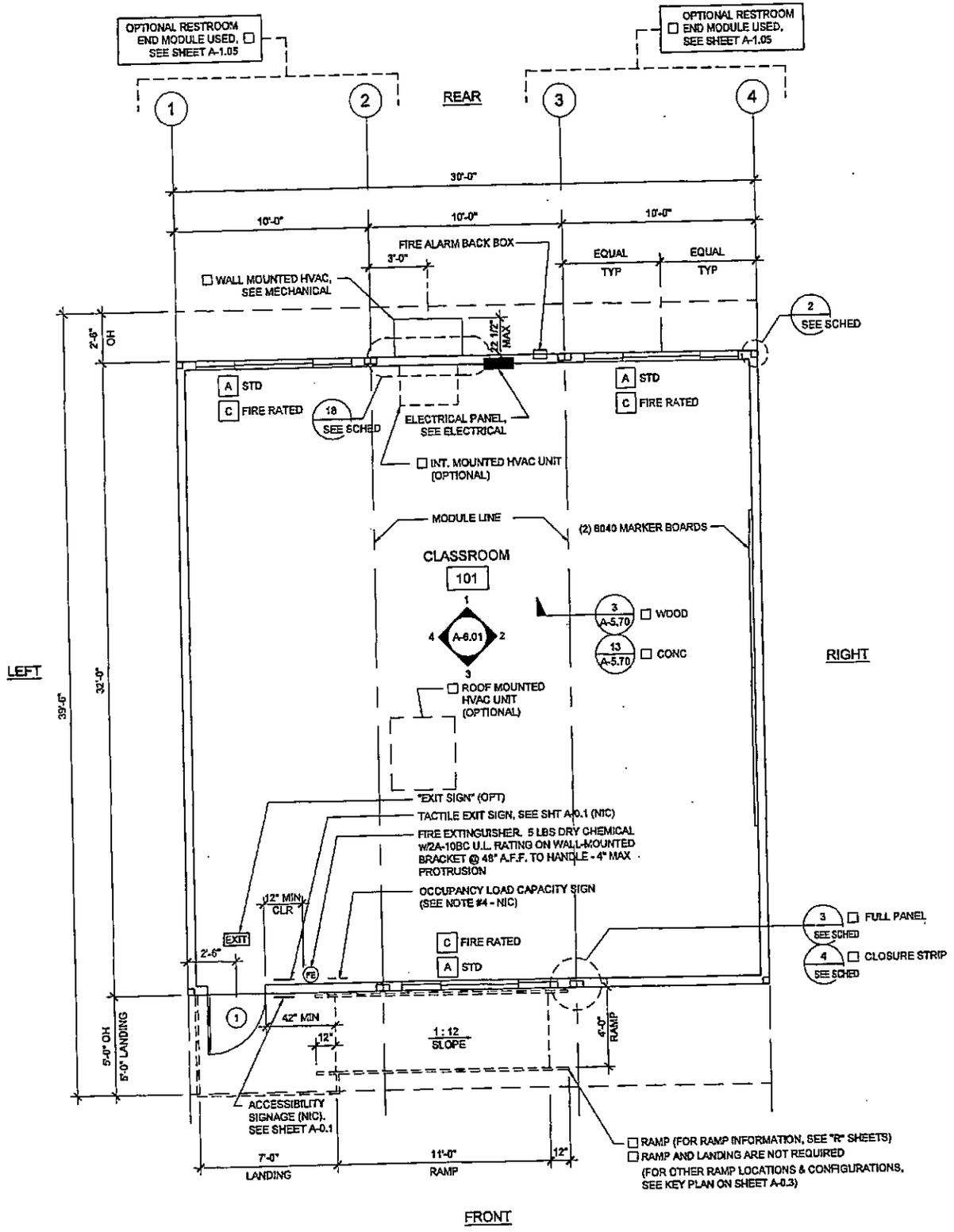

AS

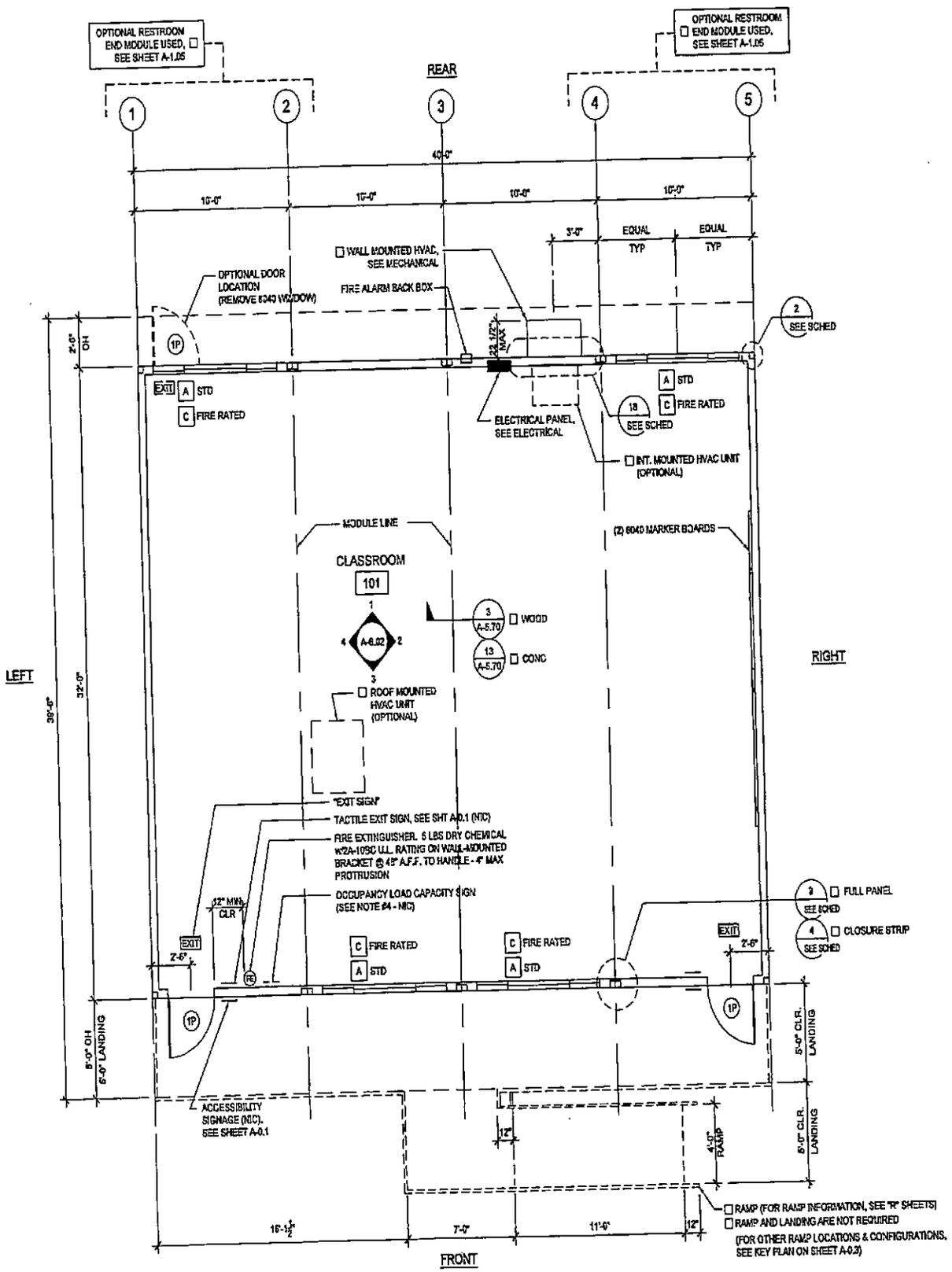

A-8

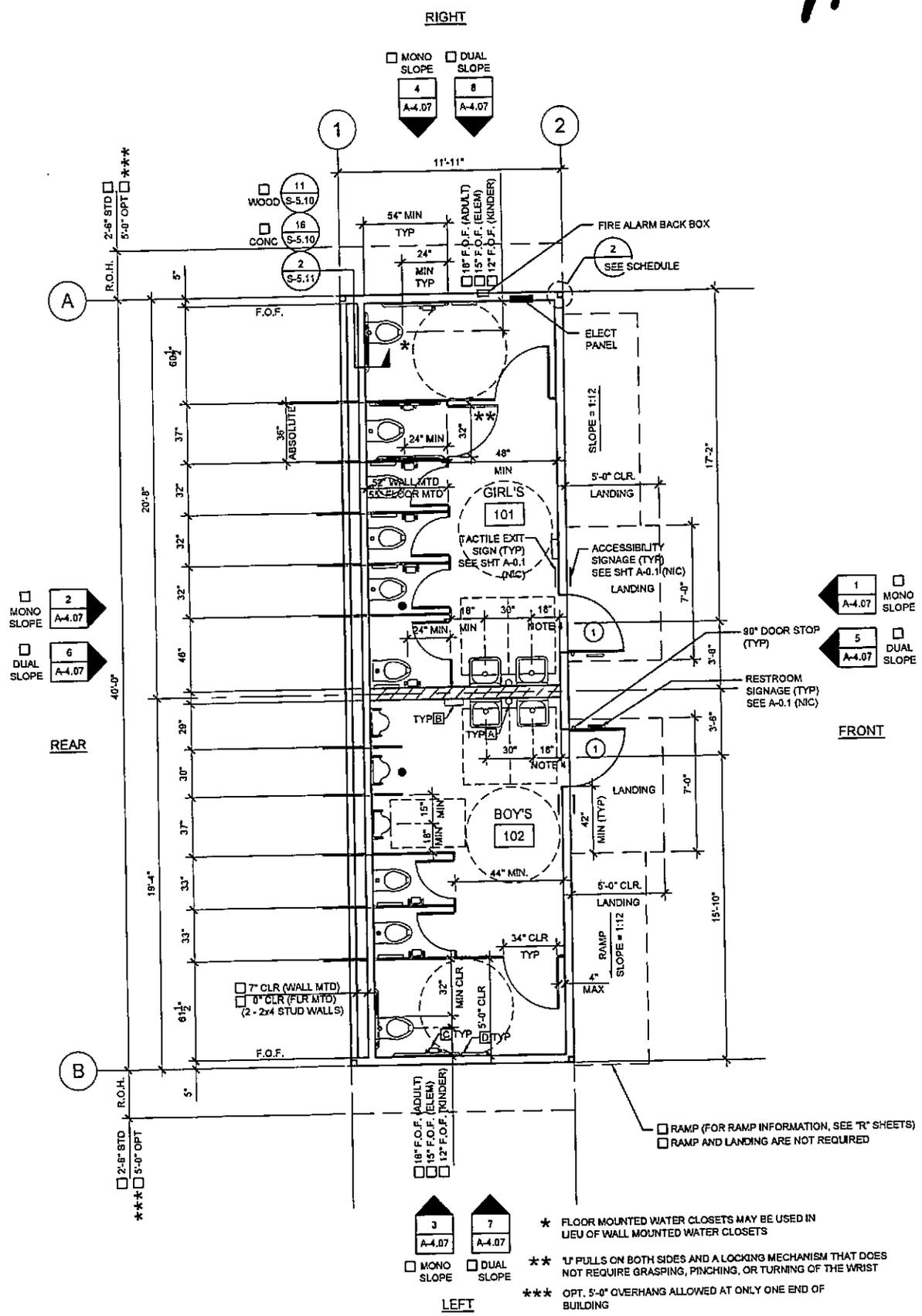

A9

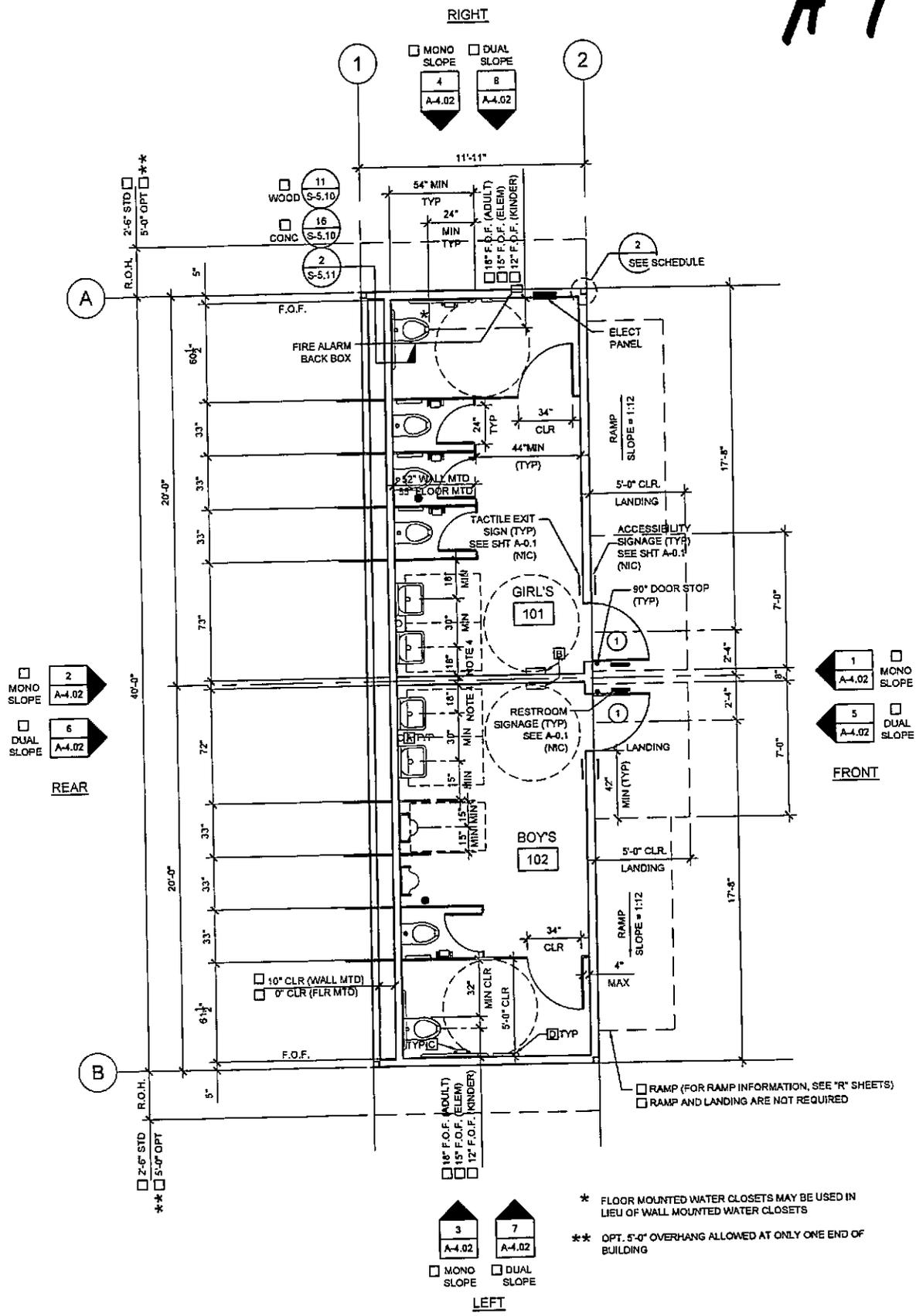

A10

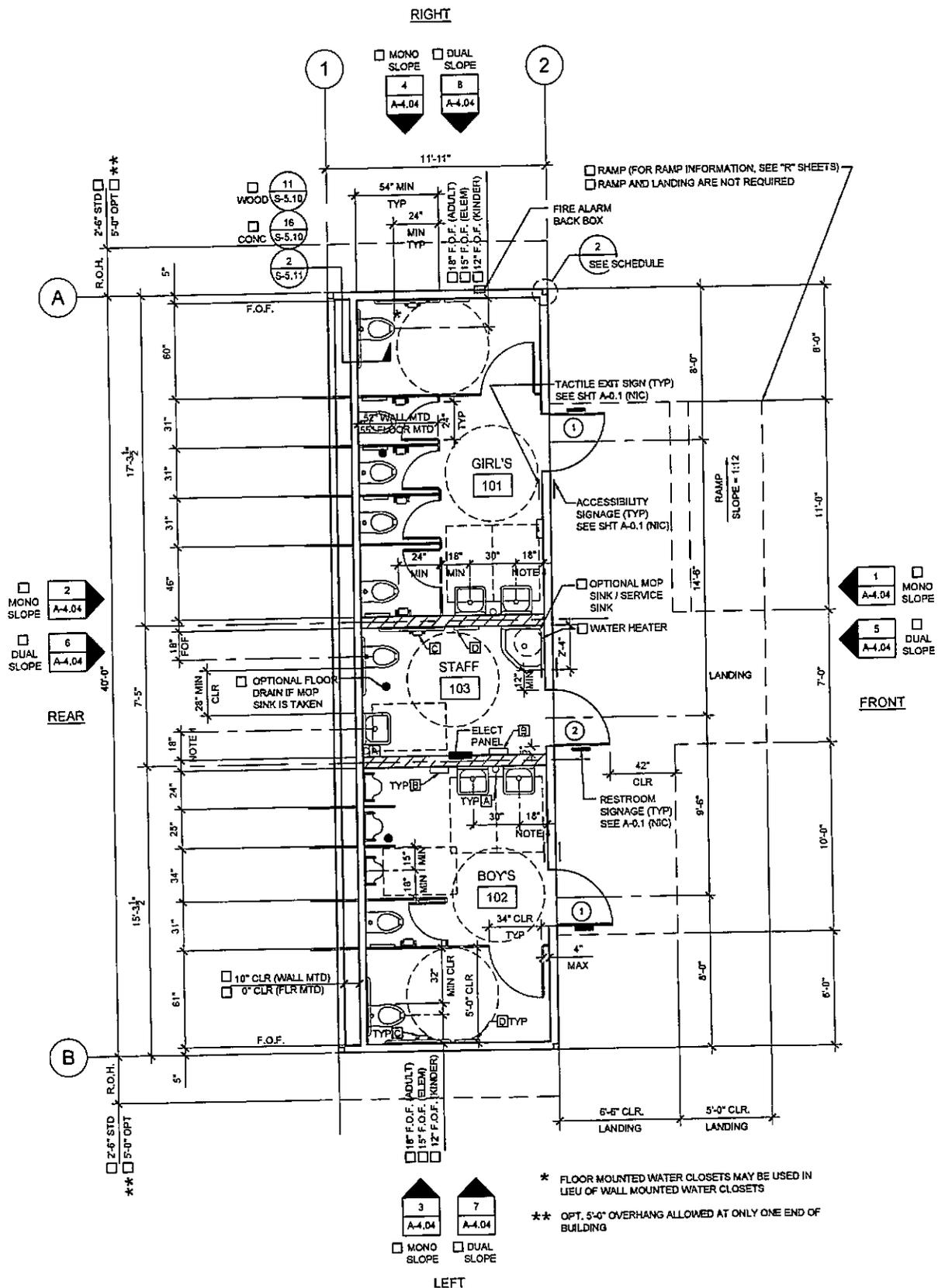

B1

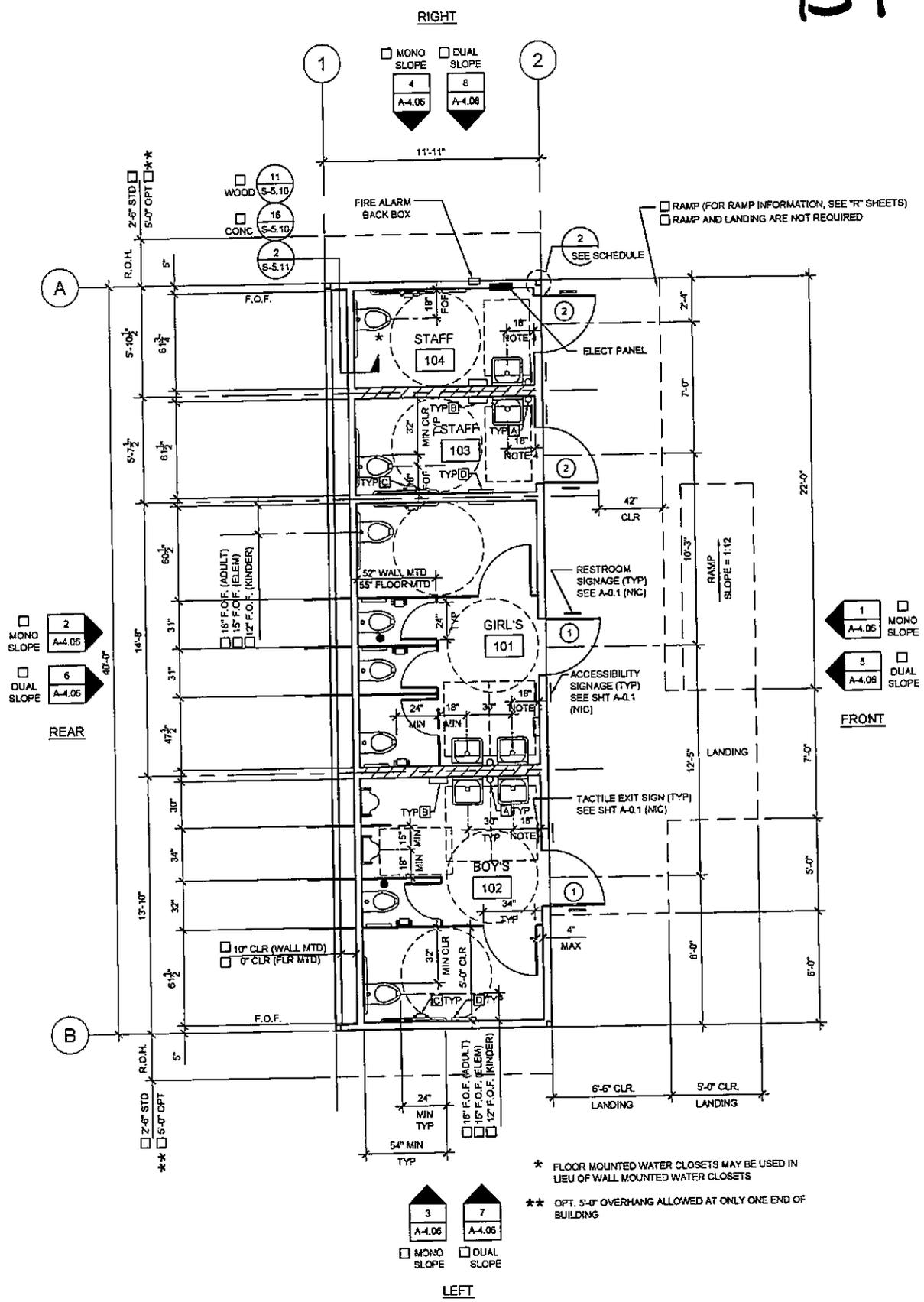

* FLOOR MOUNTED WATER CLOSETS MAY BE USED IN LIEU OF WALL MOUNTED WATER CLOSETS

** OPT. 5'-0" OVERHANG ALLOWED AT ONLY ONE END OF BUILDING

B2

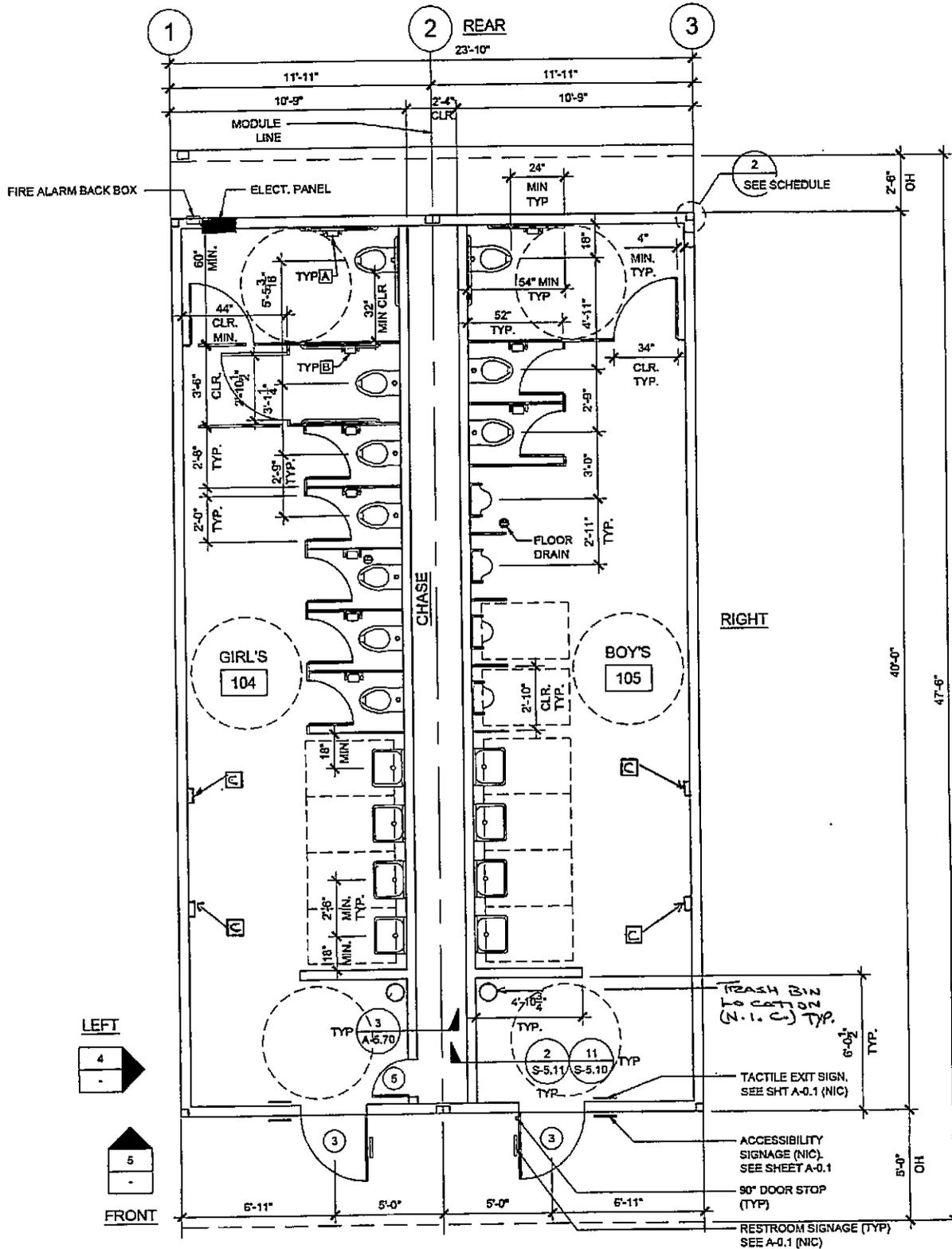

B4

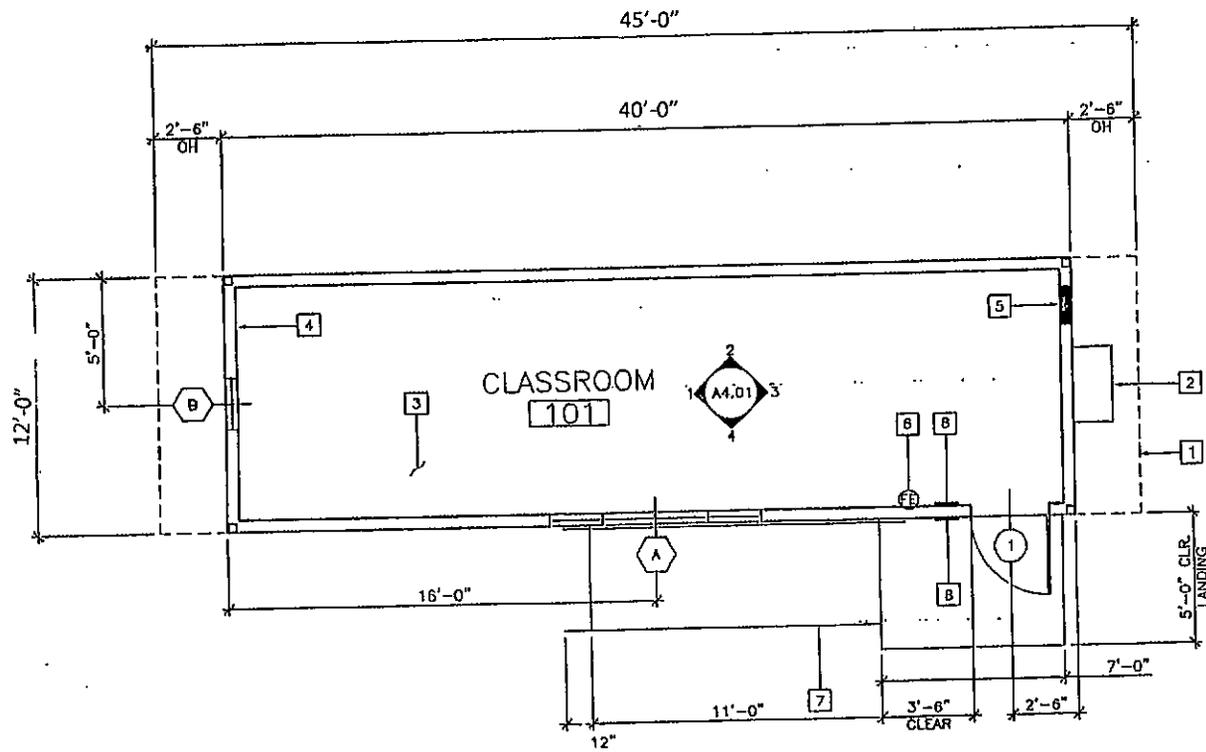

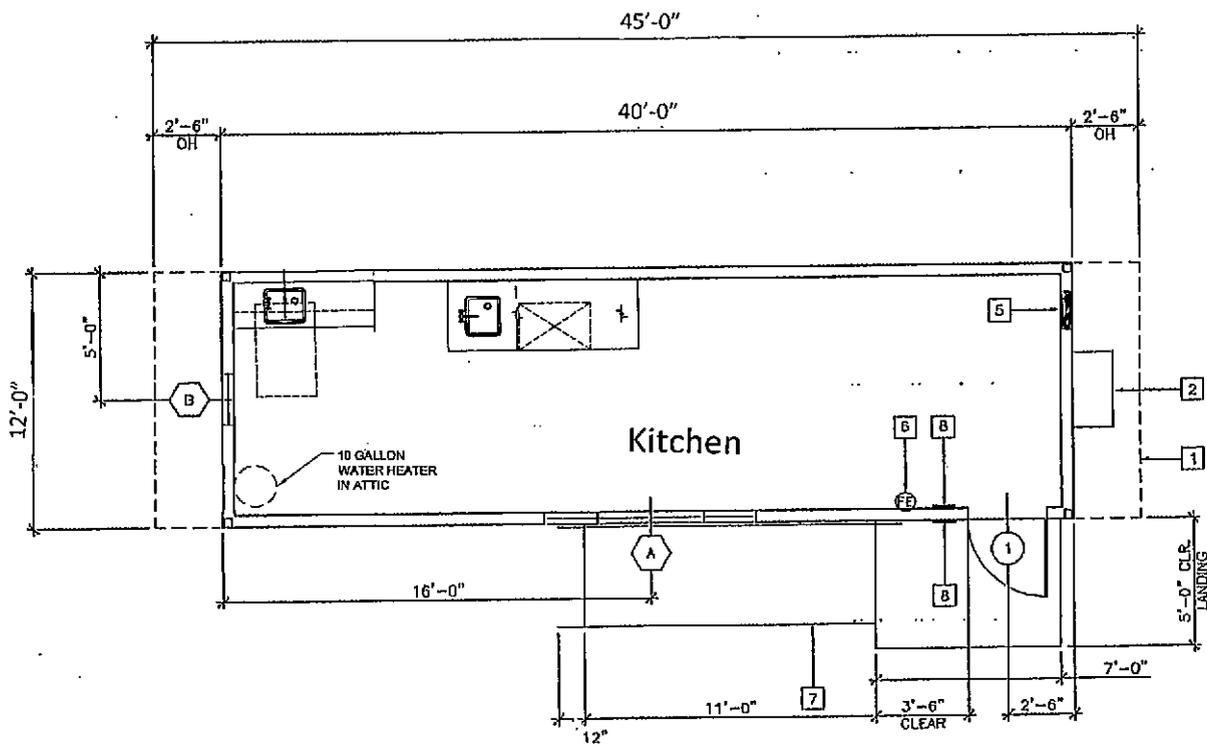

BS

B6

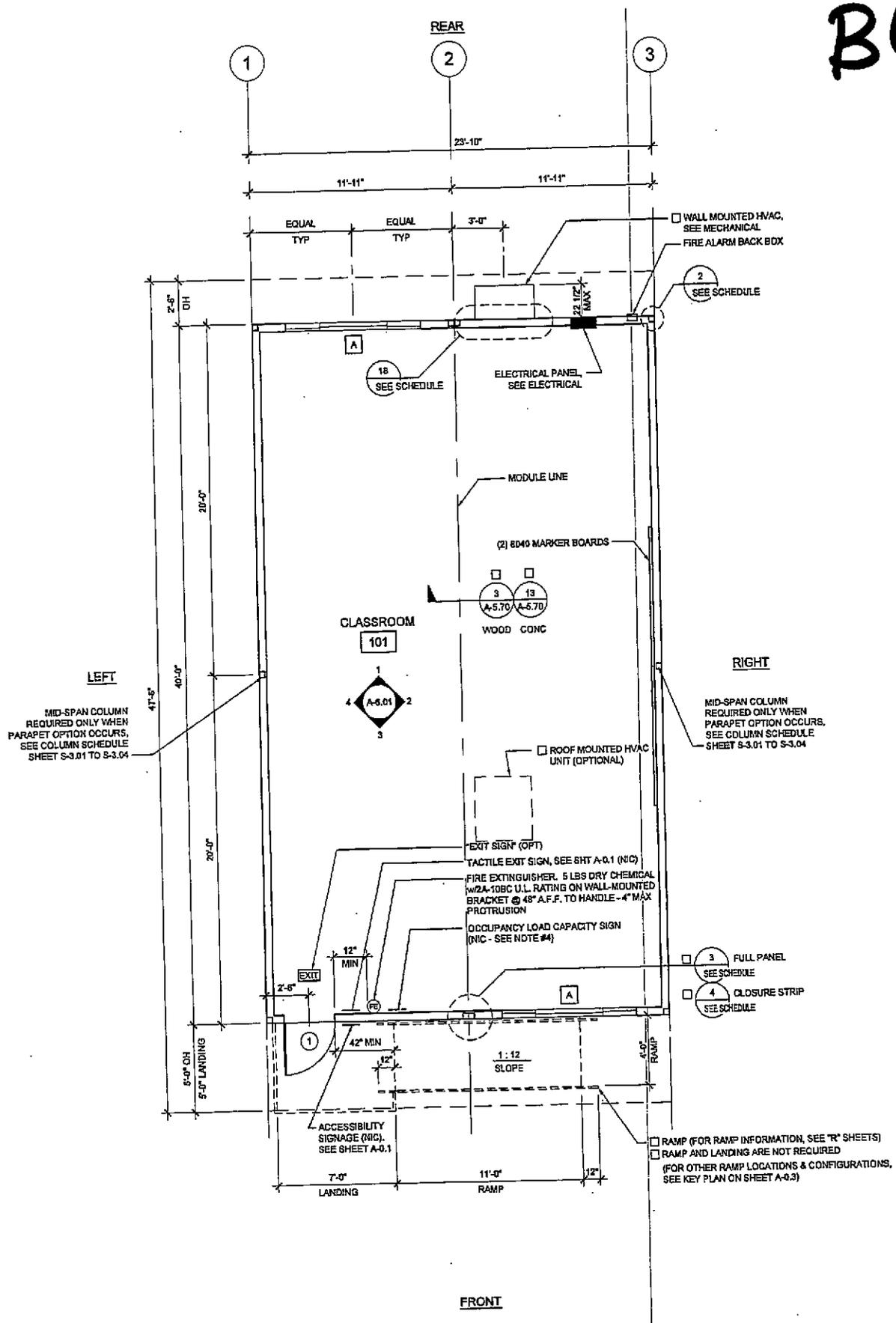

B7

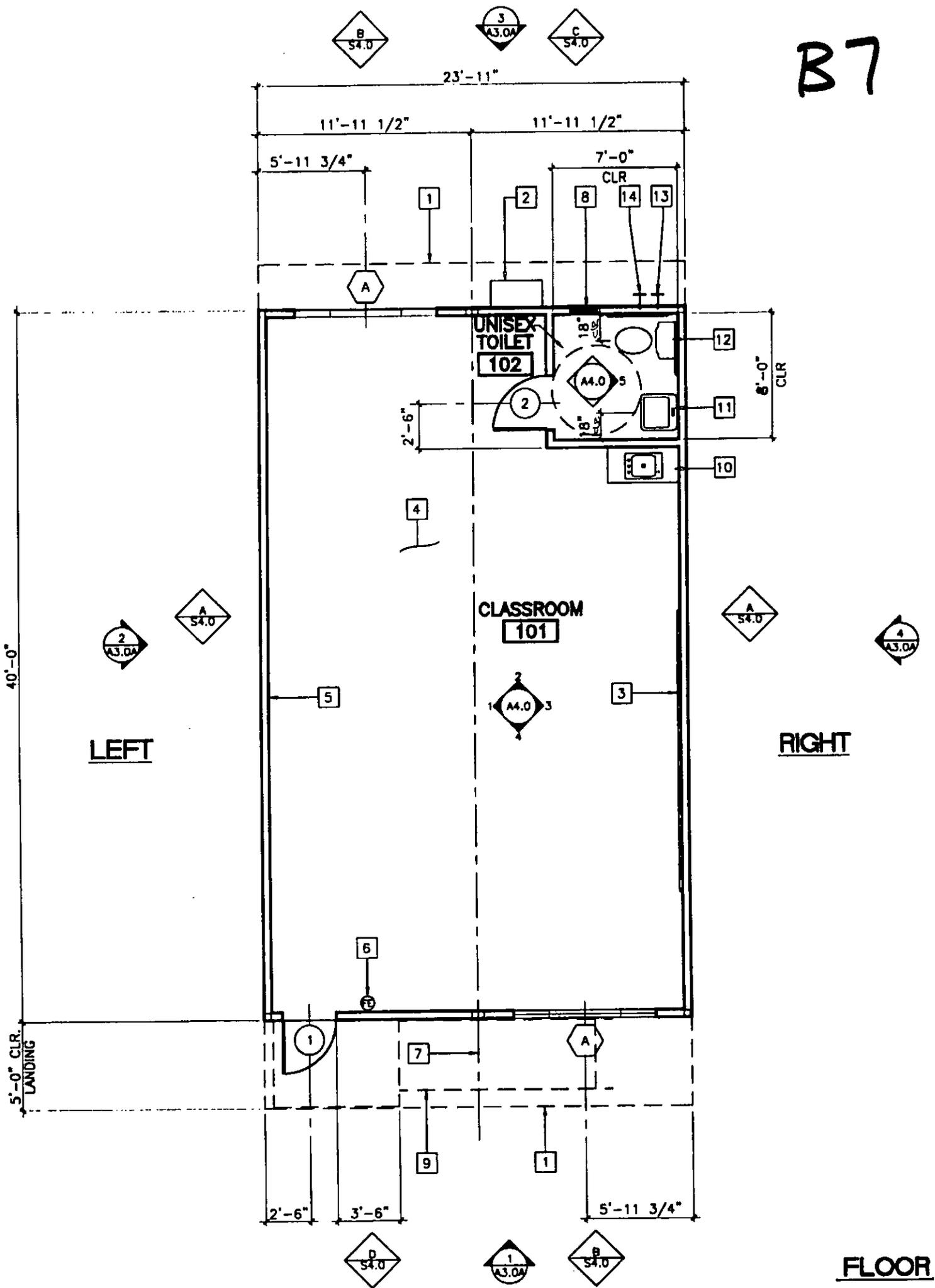

FLOOR

REAR
3
A4.02 MIRROR
IMAGE

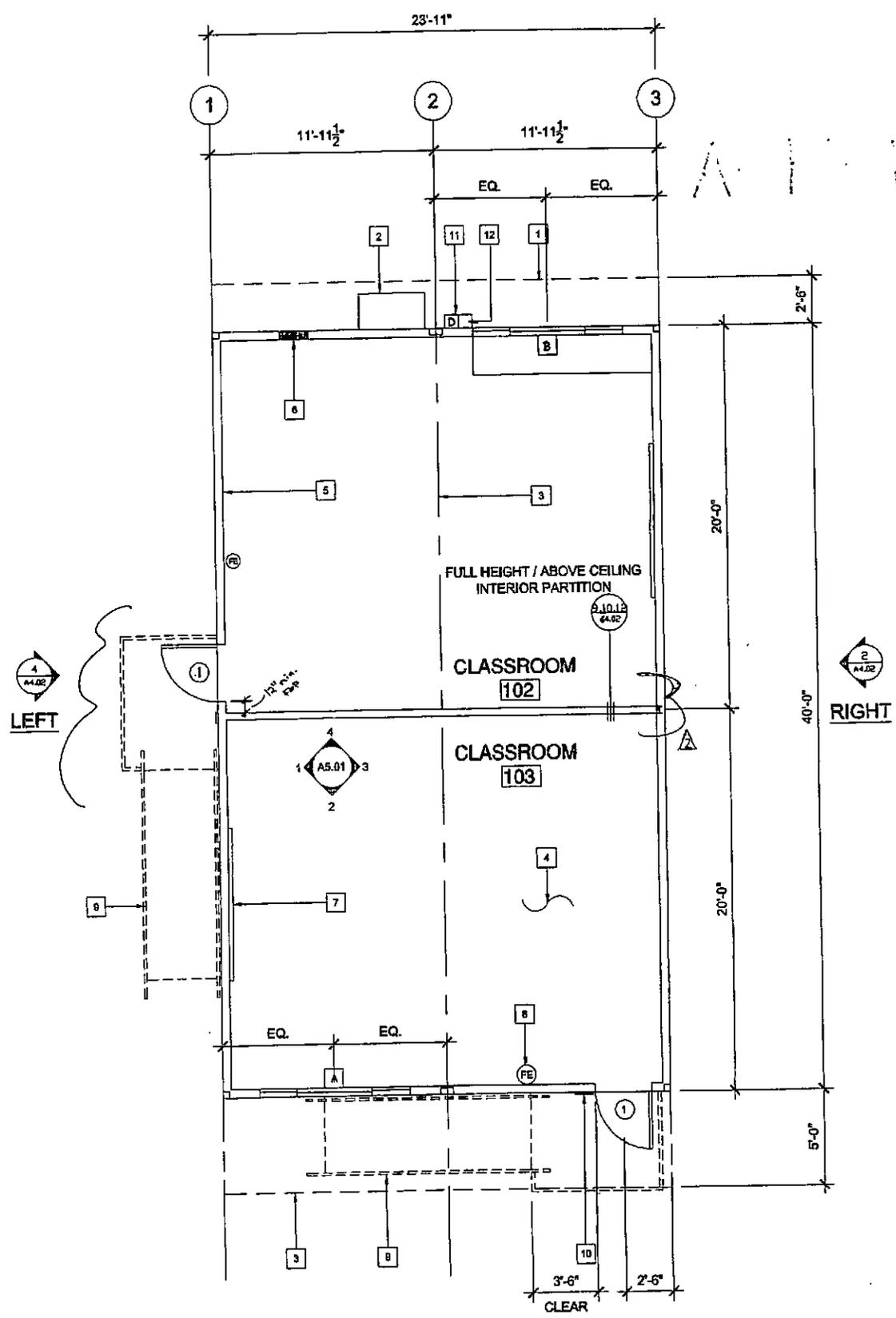

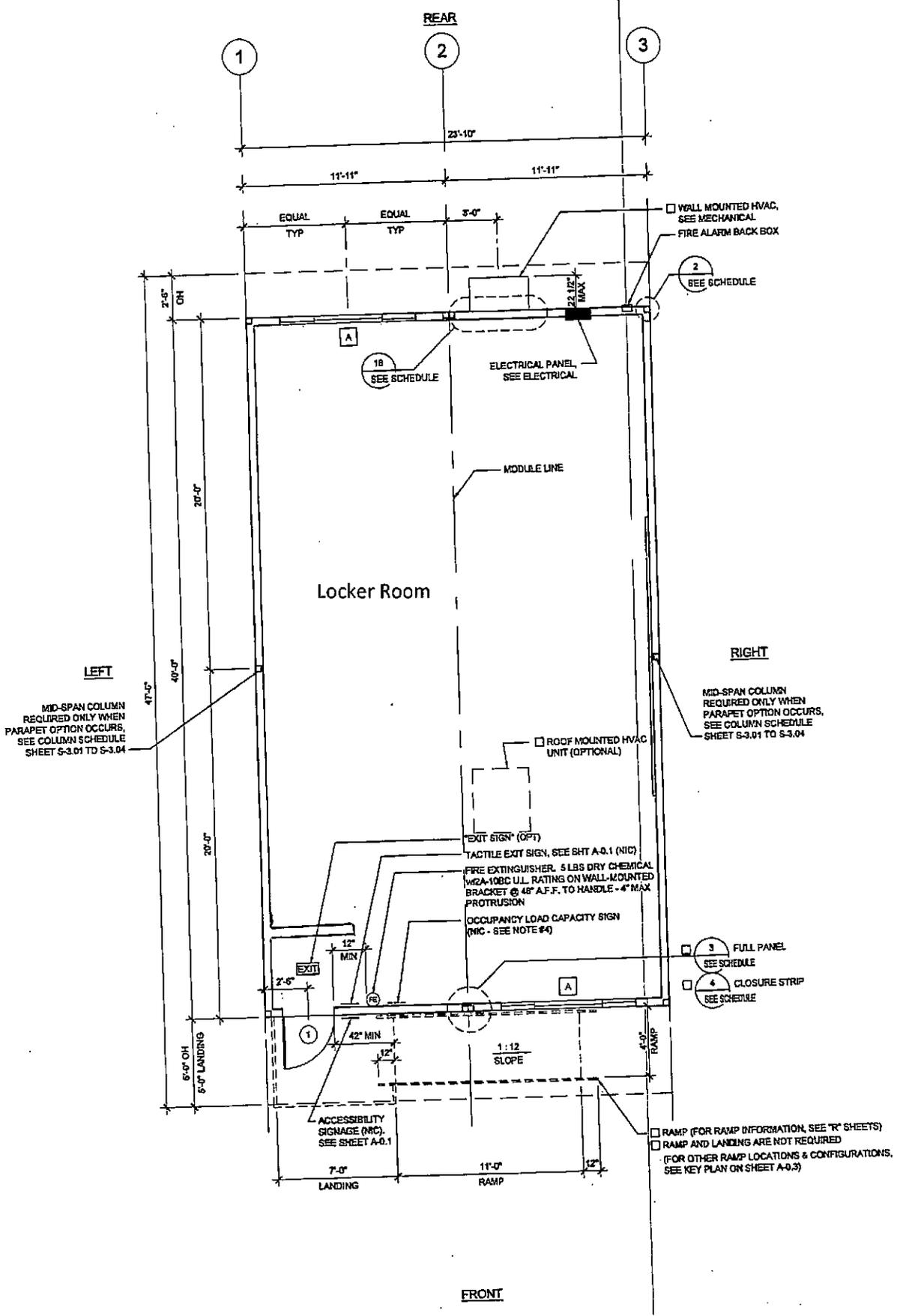

B10

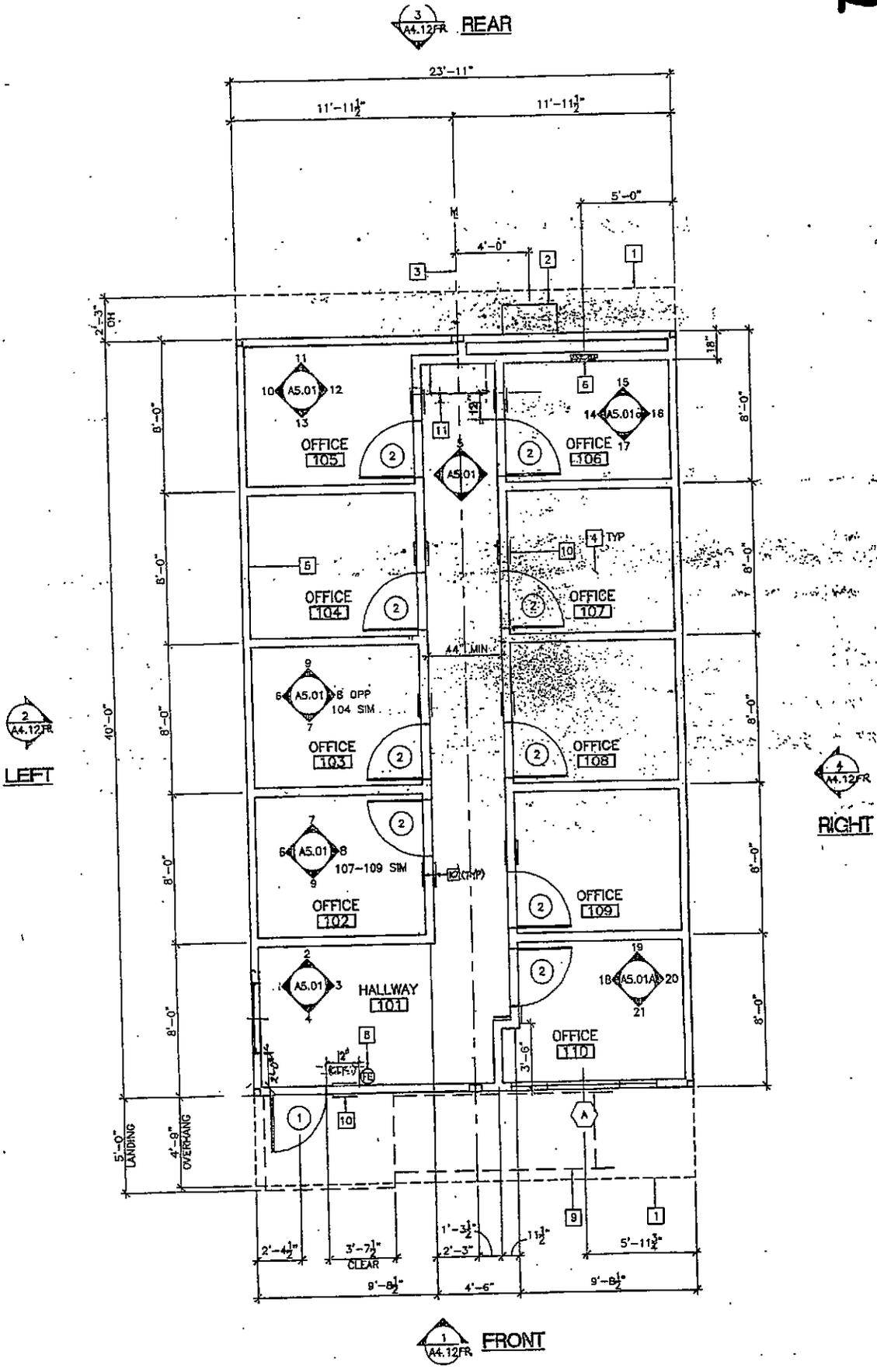

C2

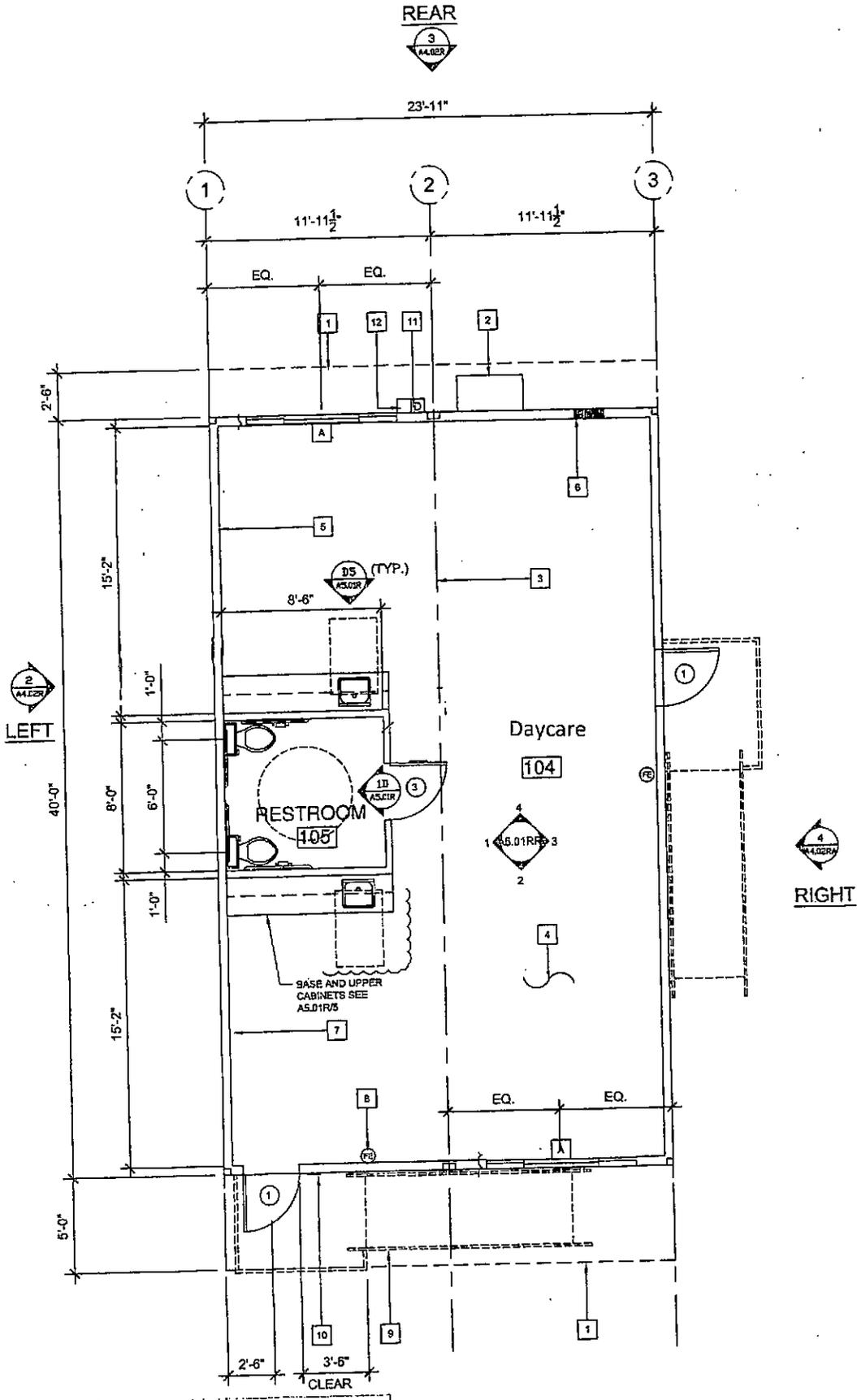

C3

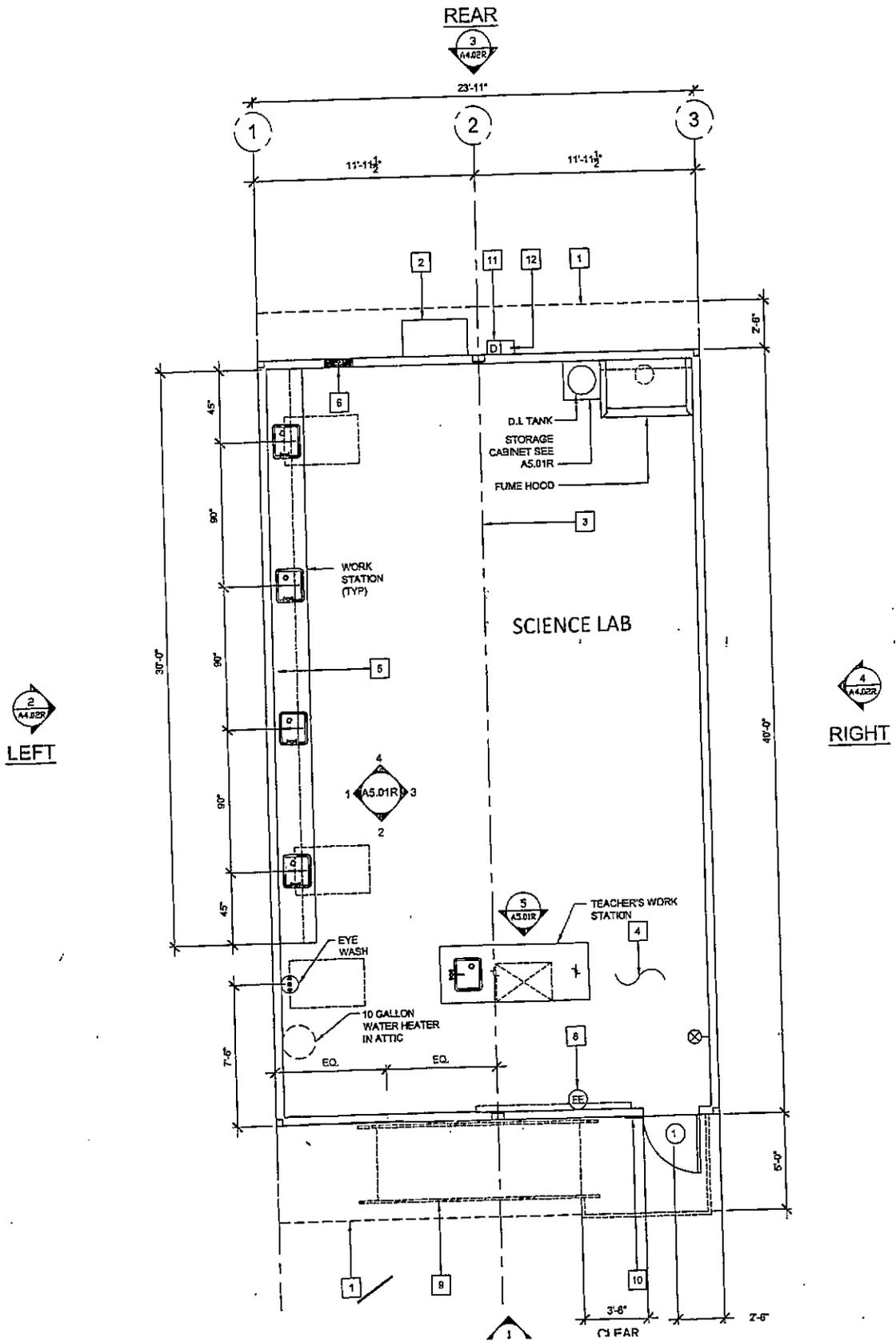

C4

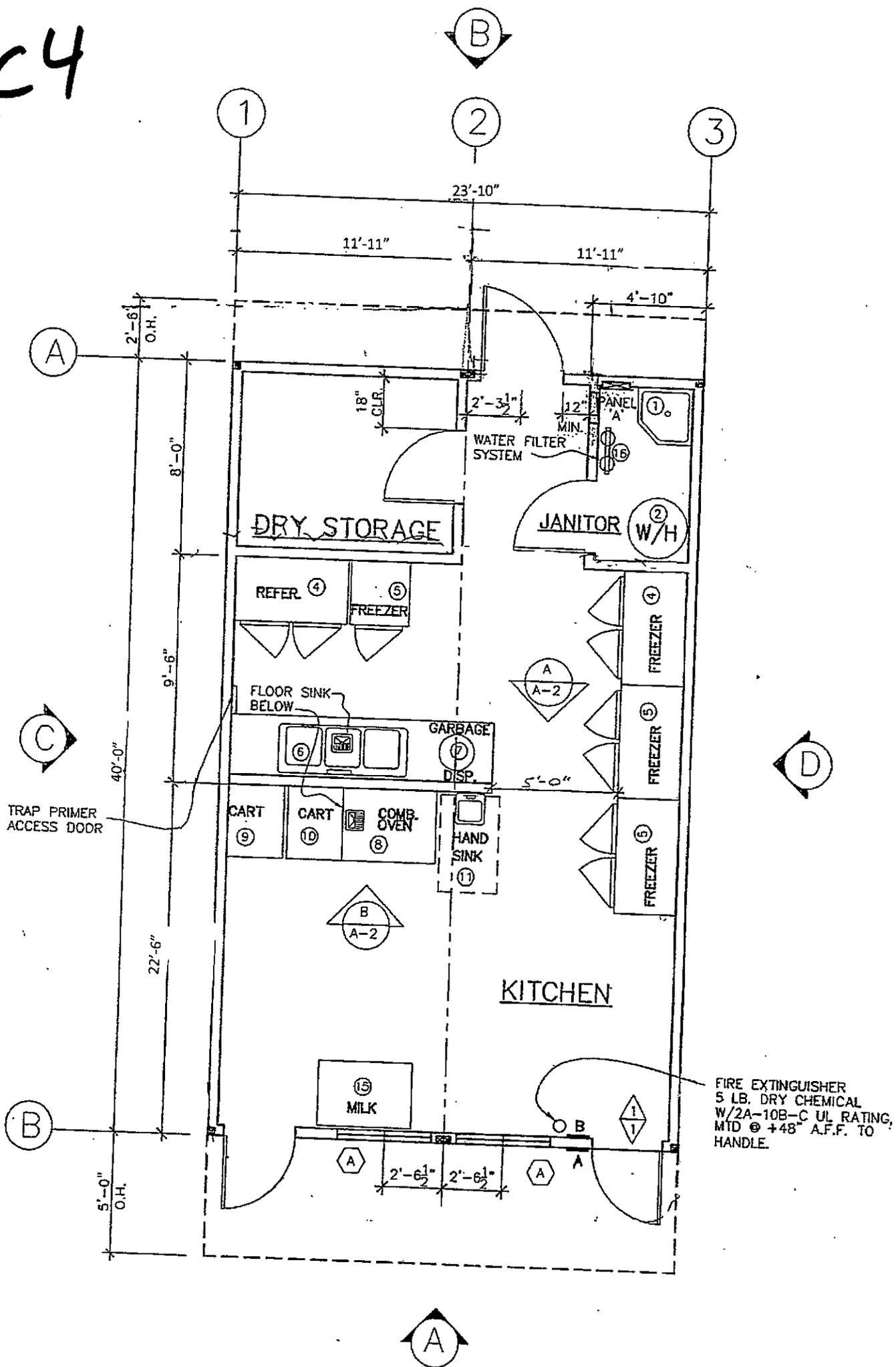

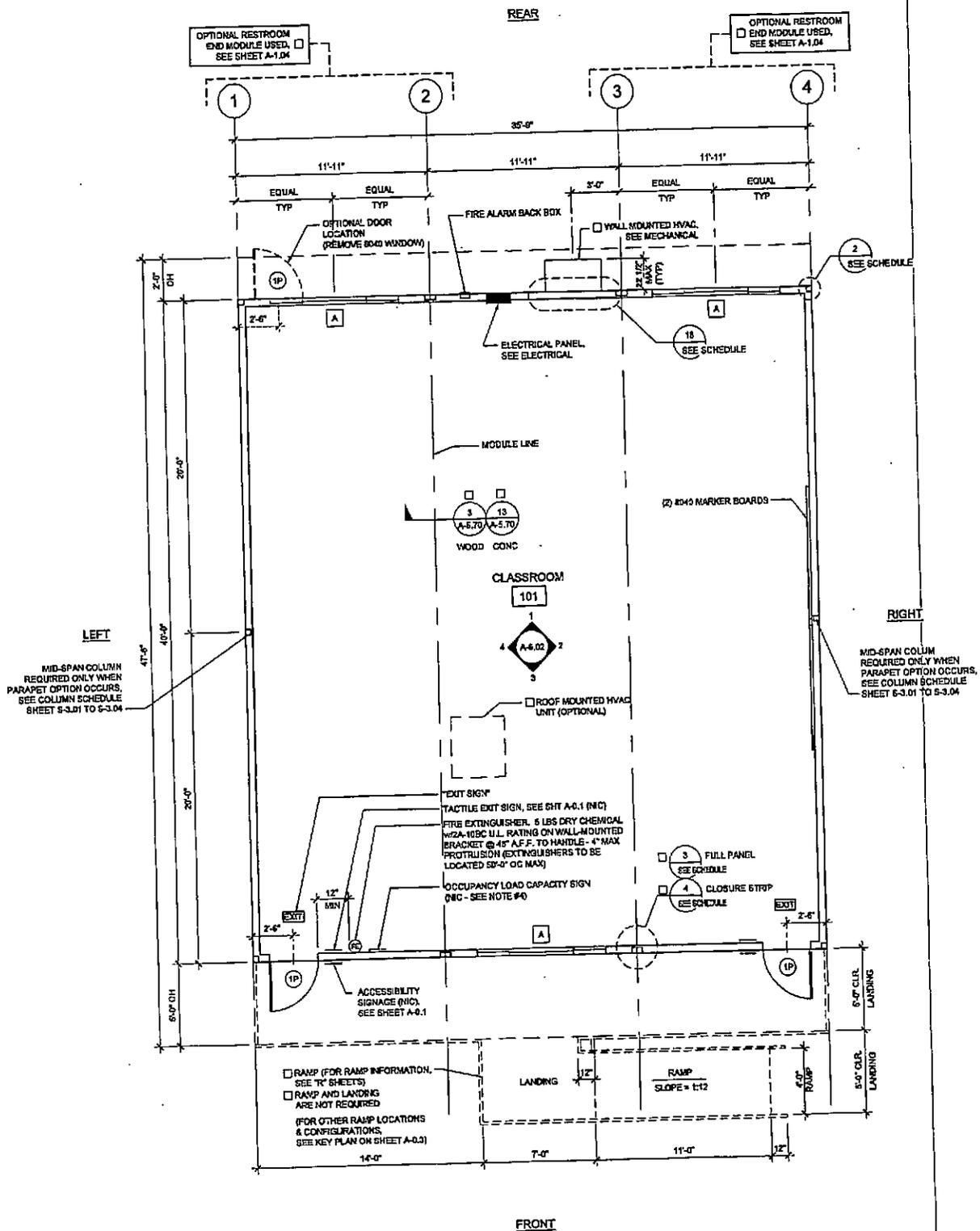

C5

C7

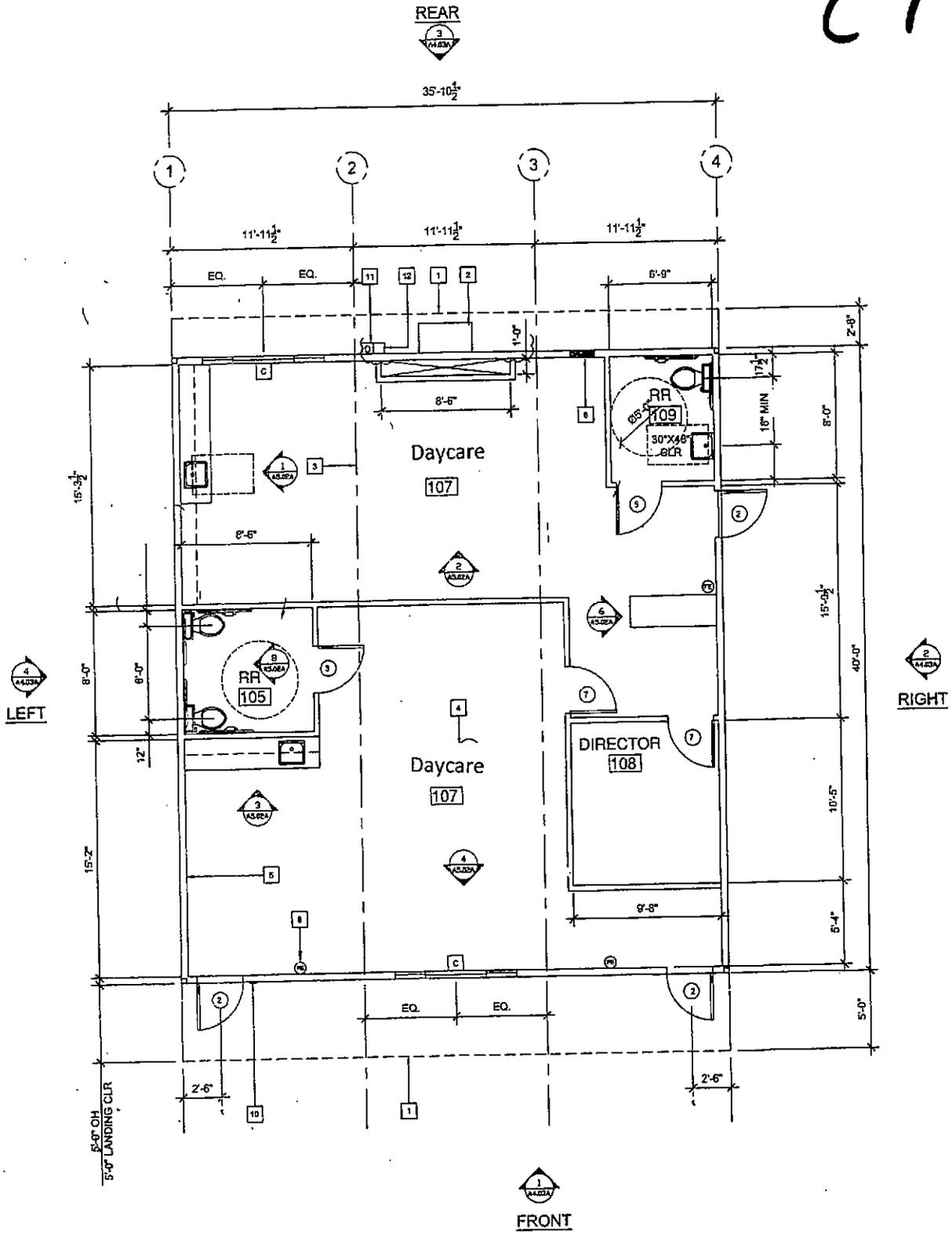

C8

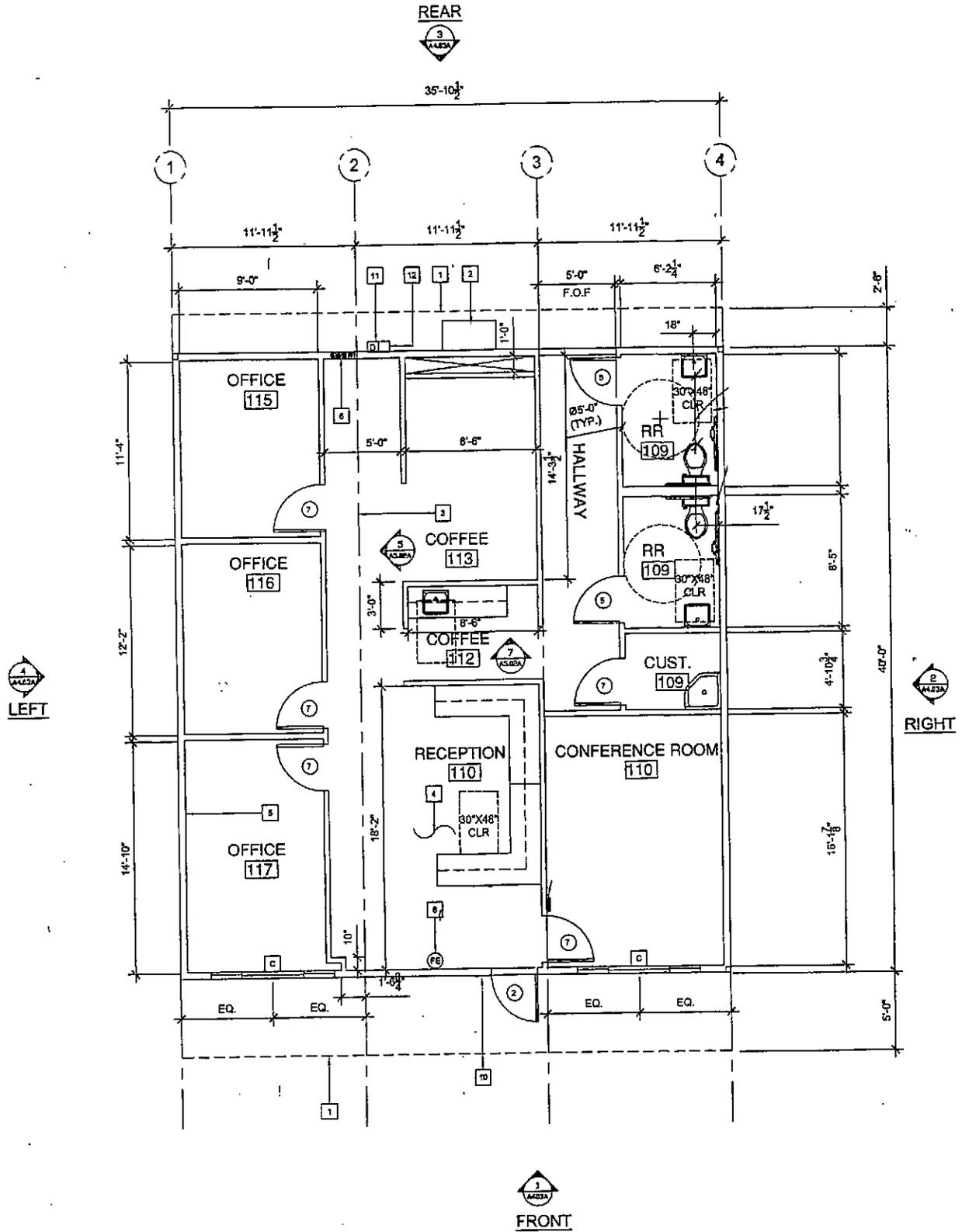

C 10

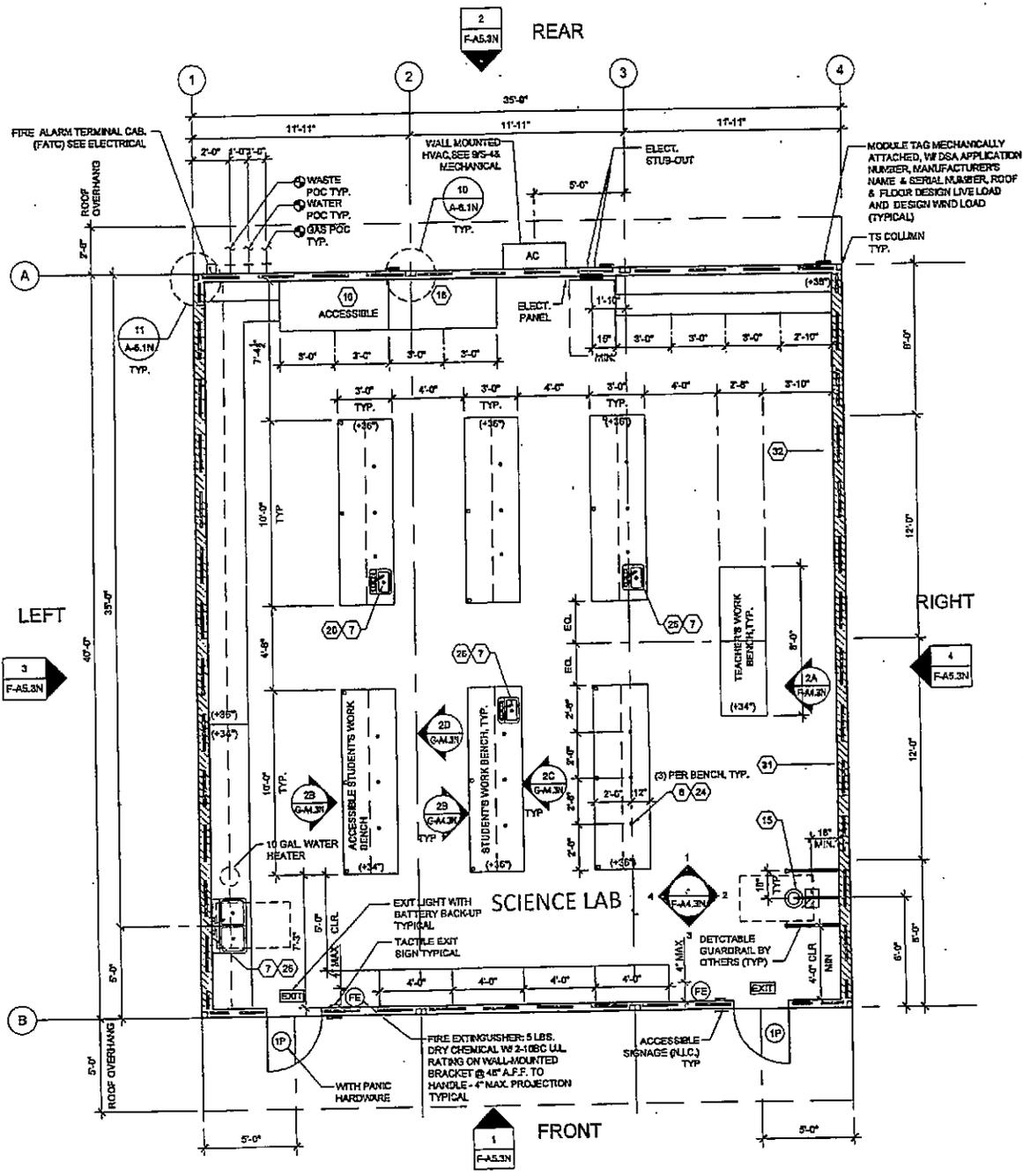

16

6' FUME HOOD

DI

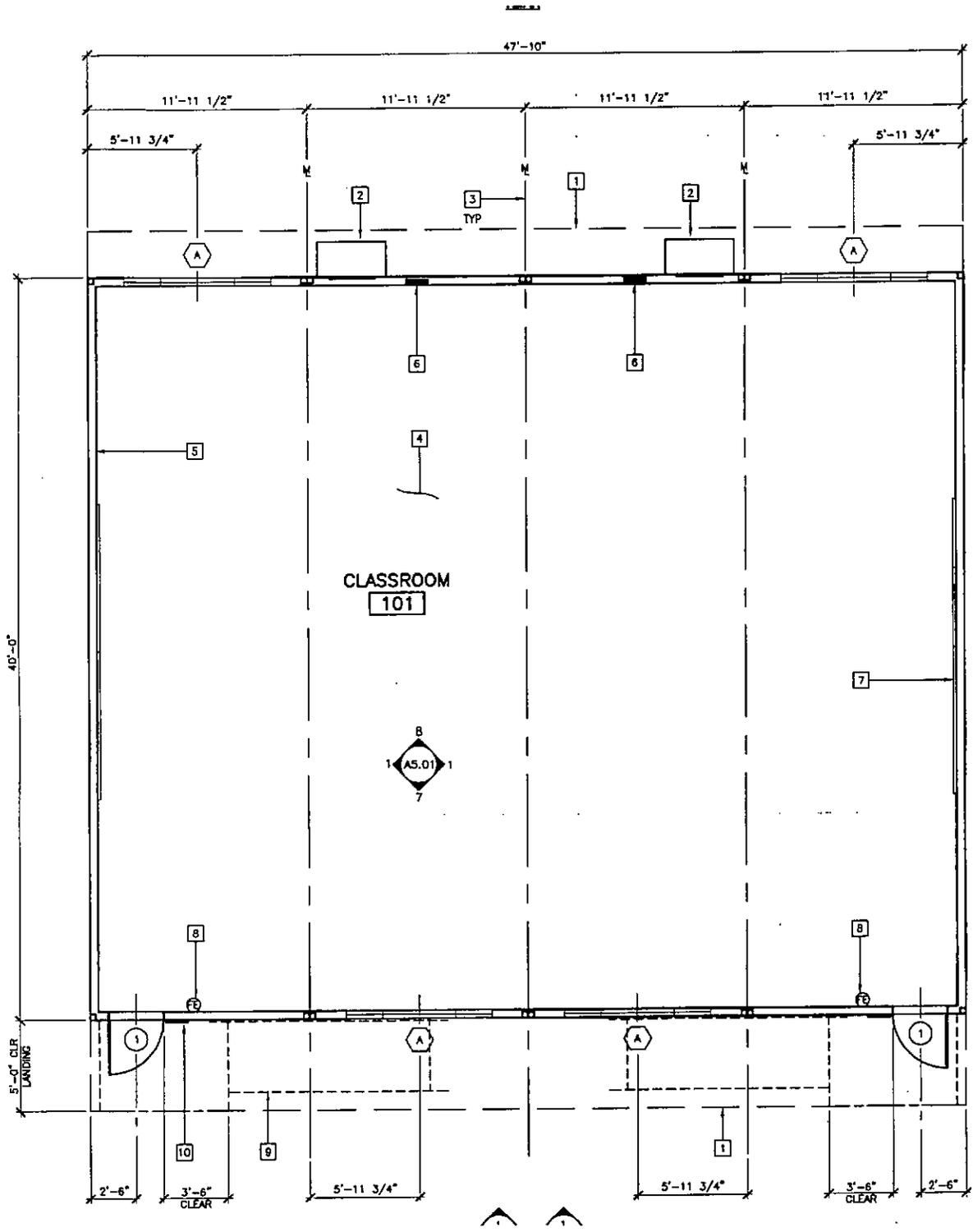

D3

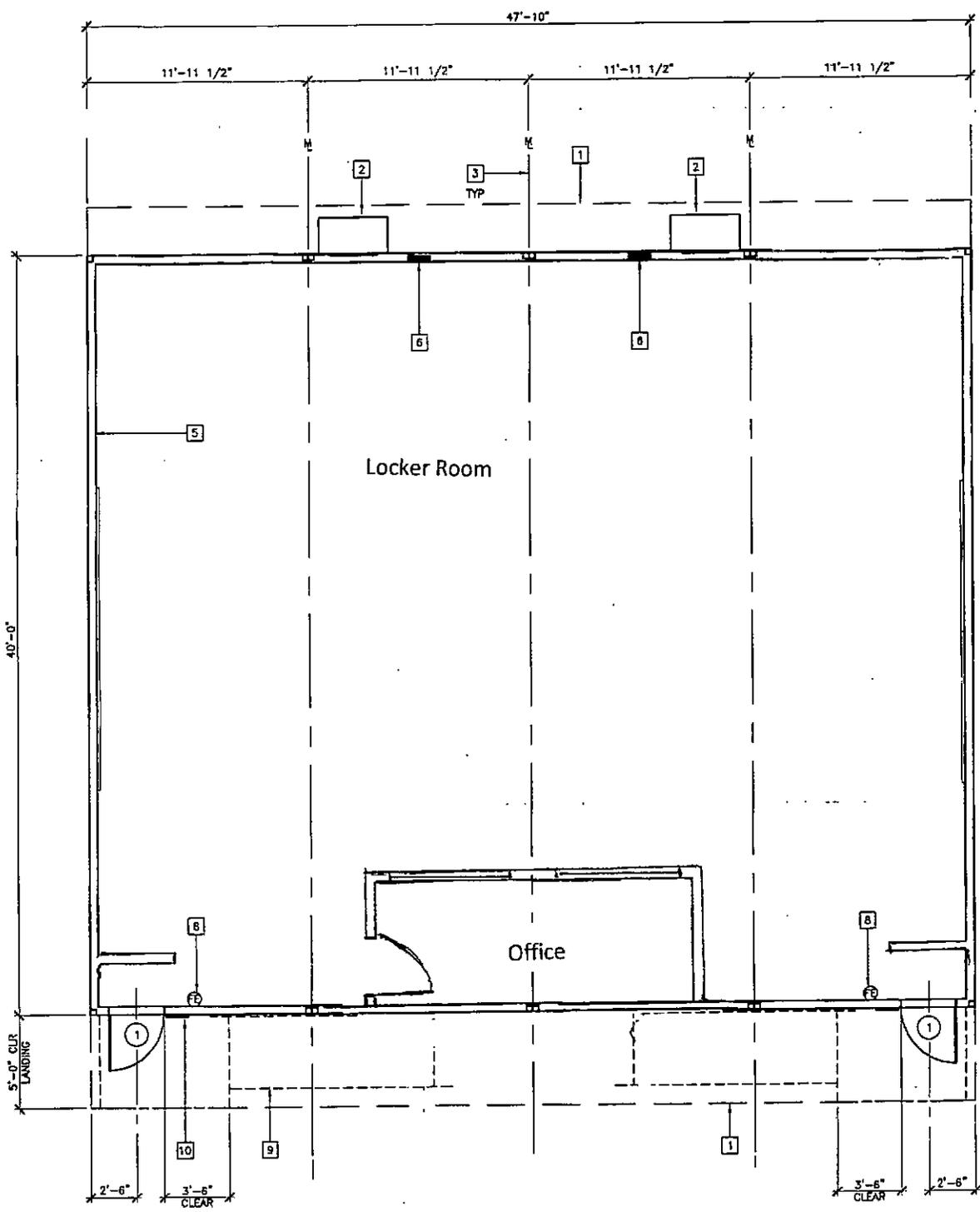

5
D

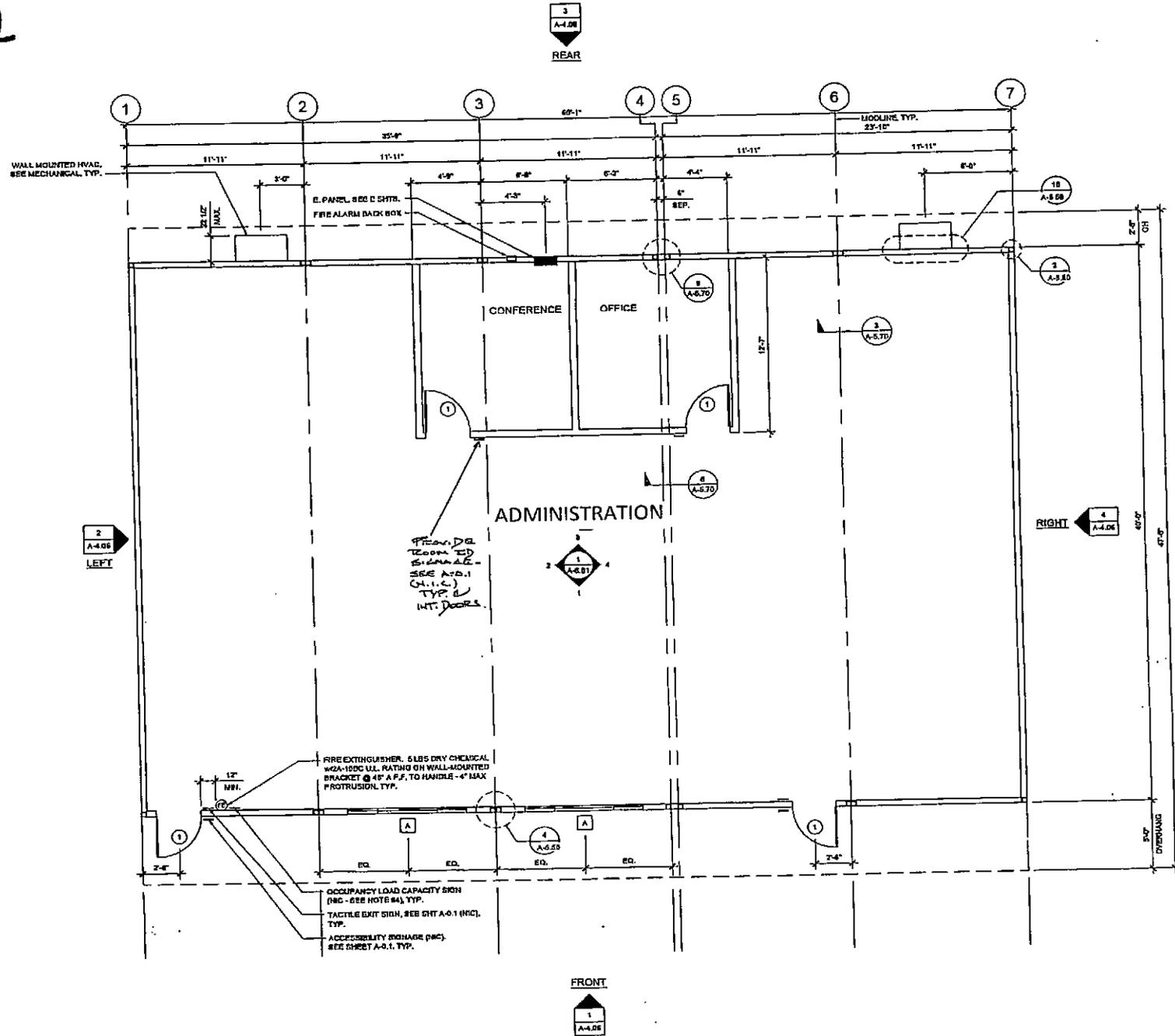

D7

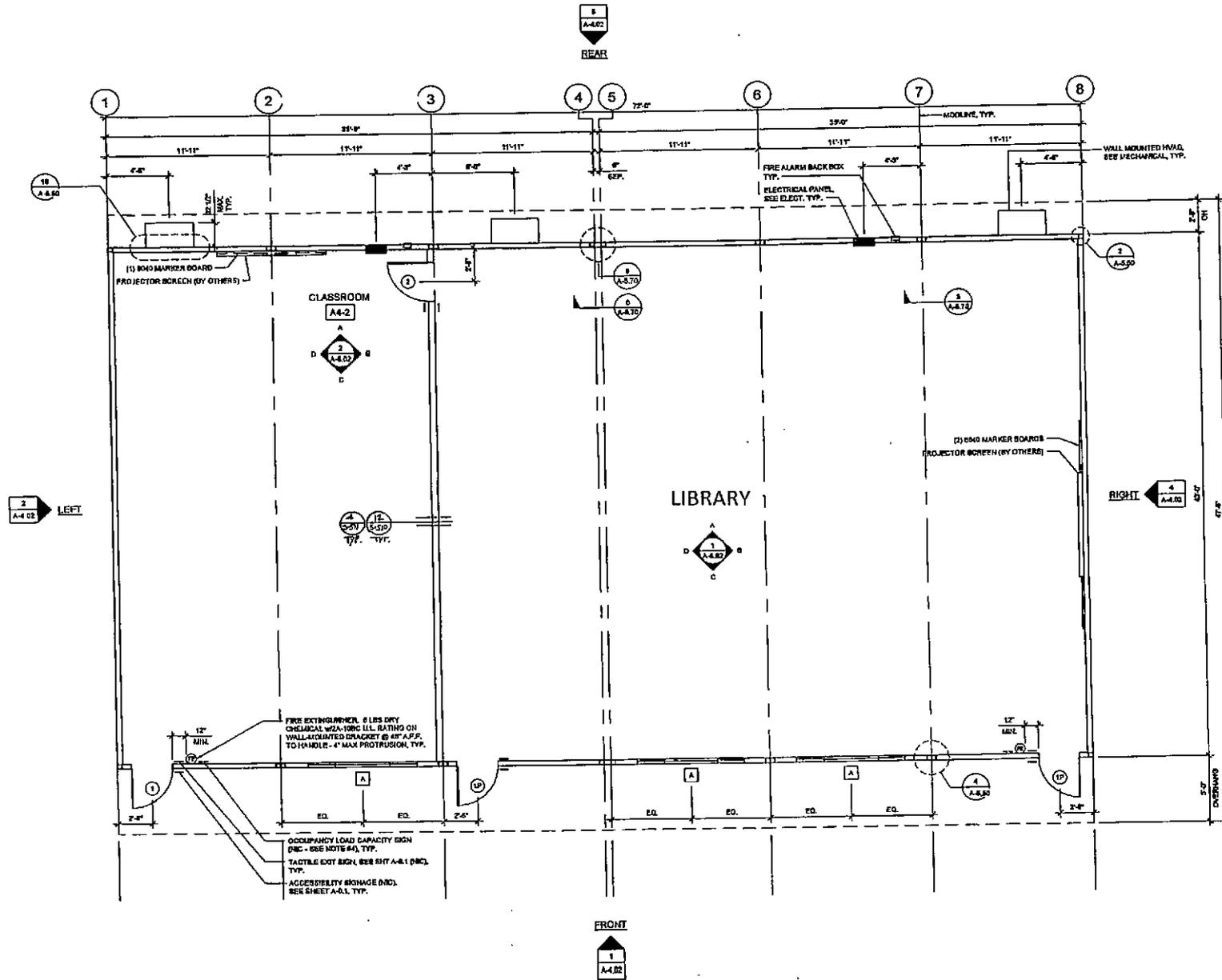

D8

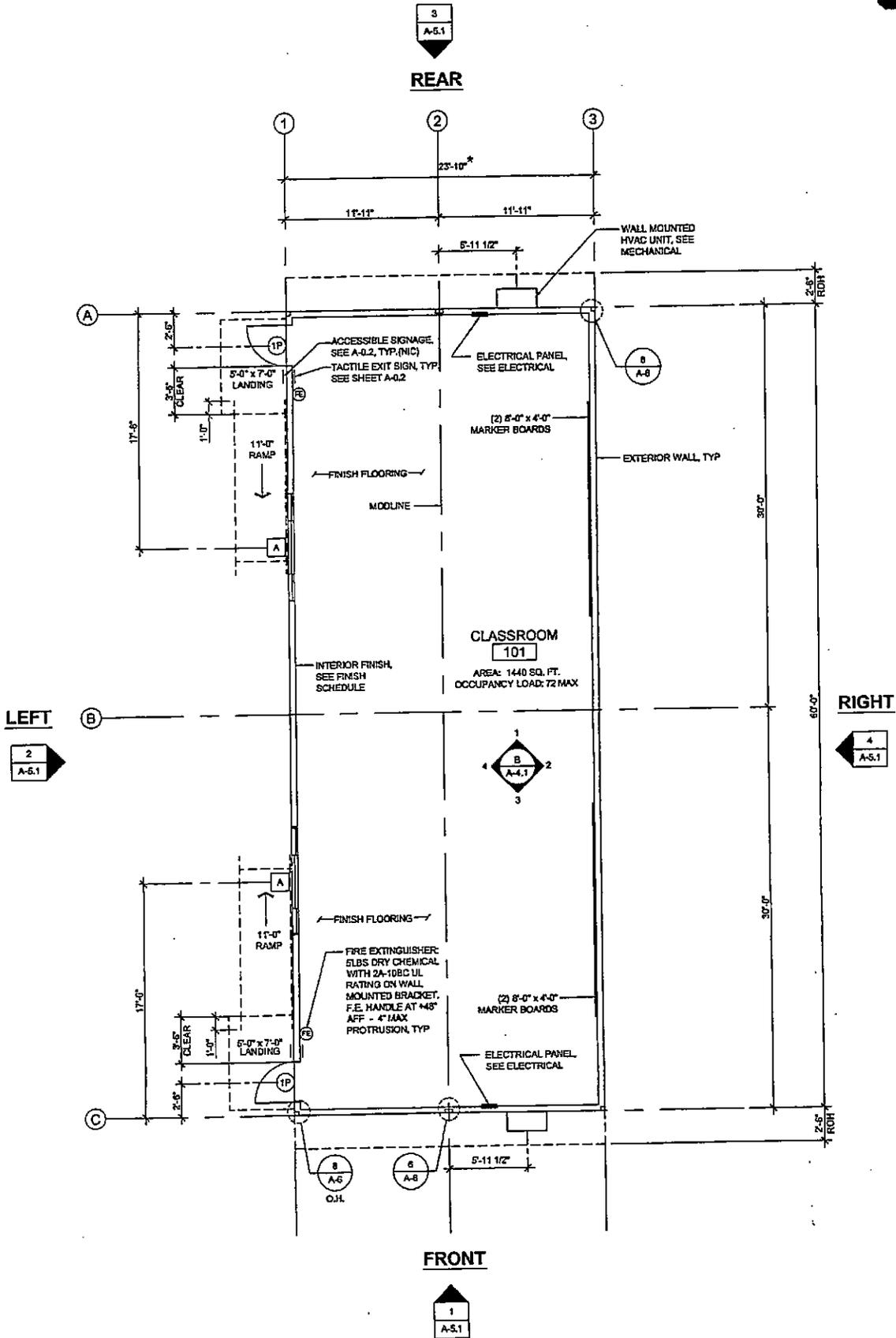

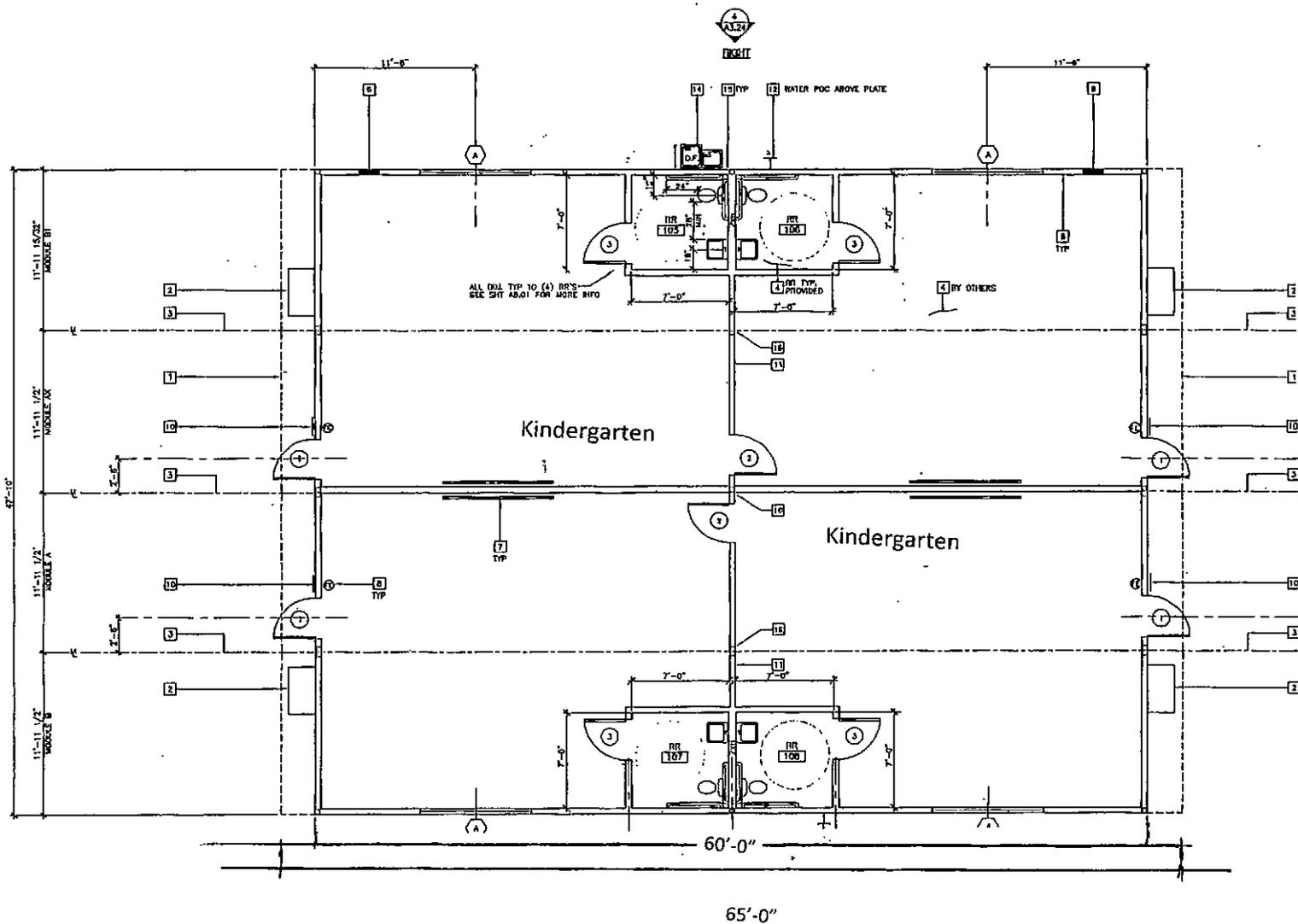

D10

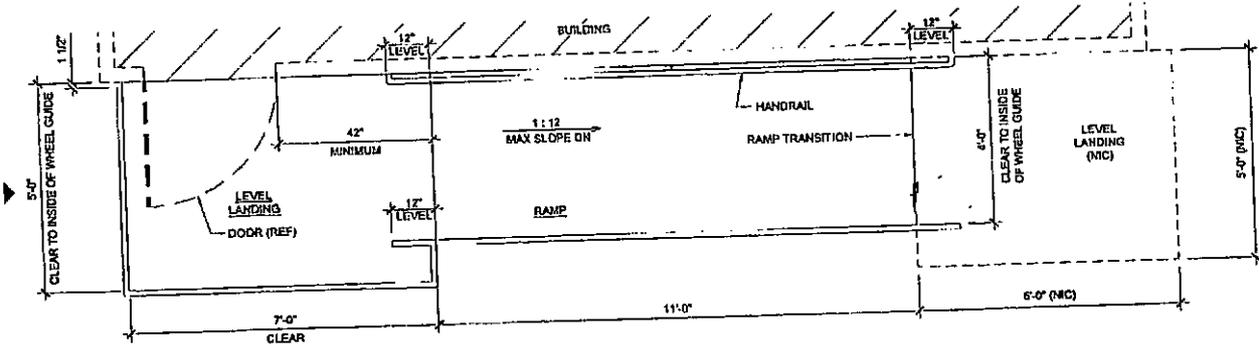
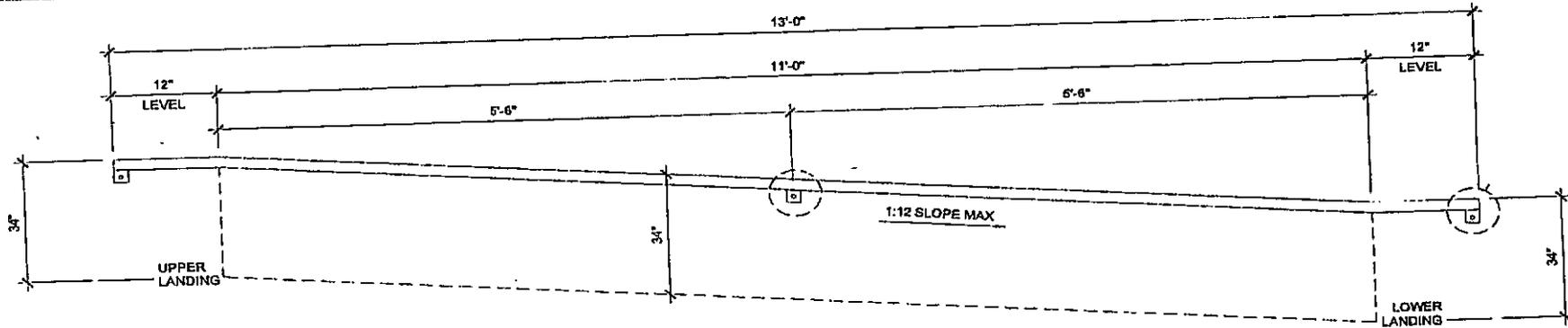
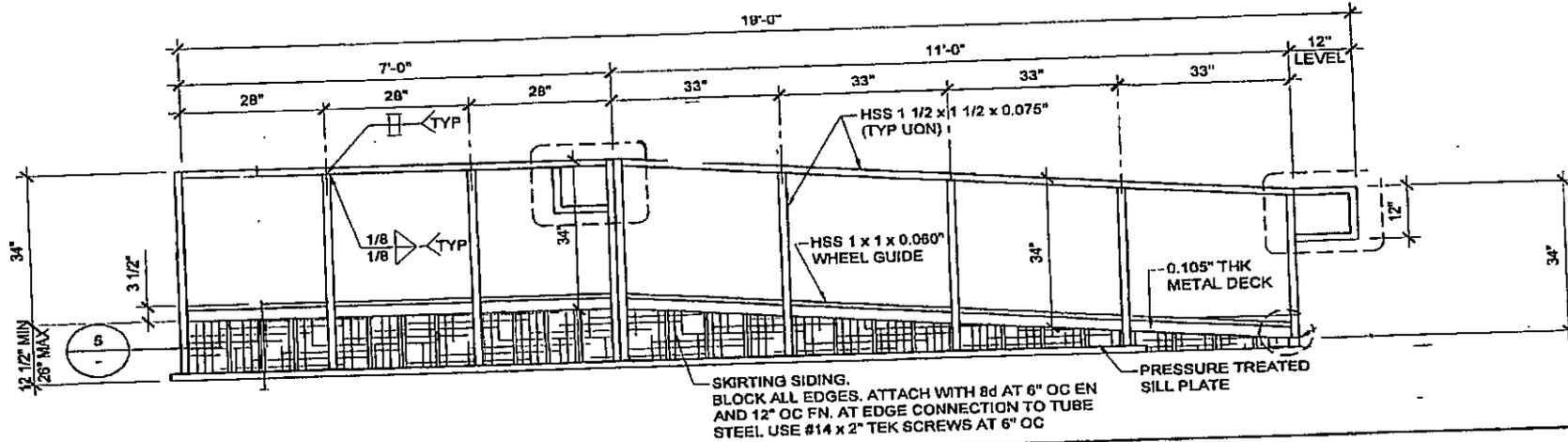

Standard Ramp

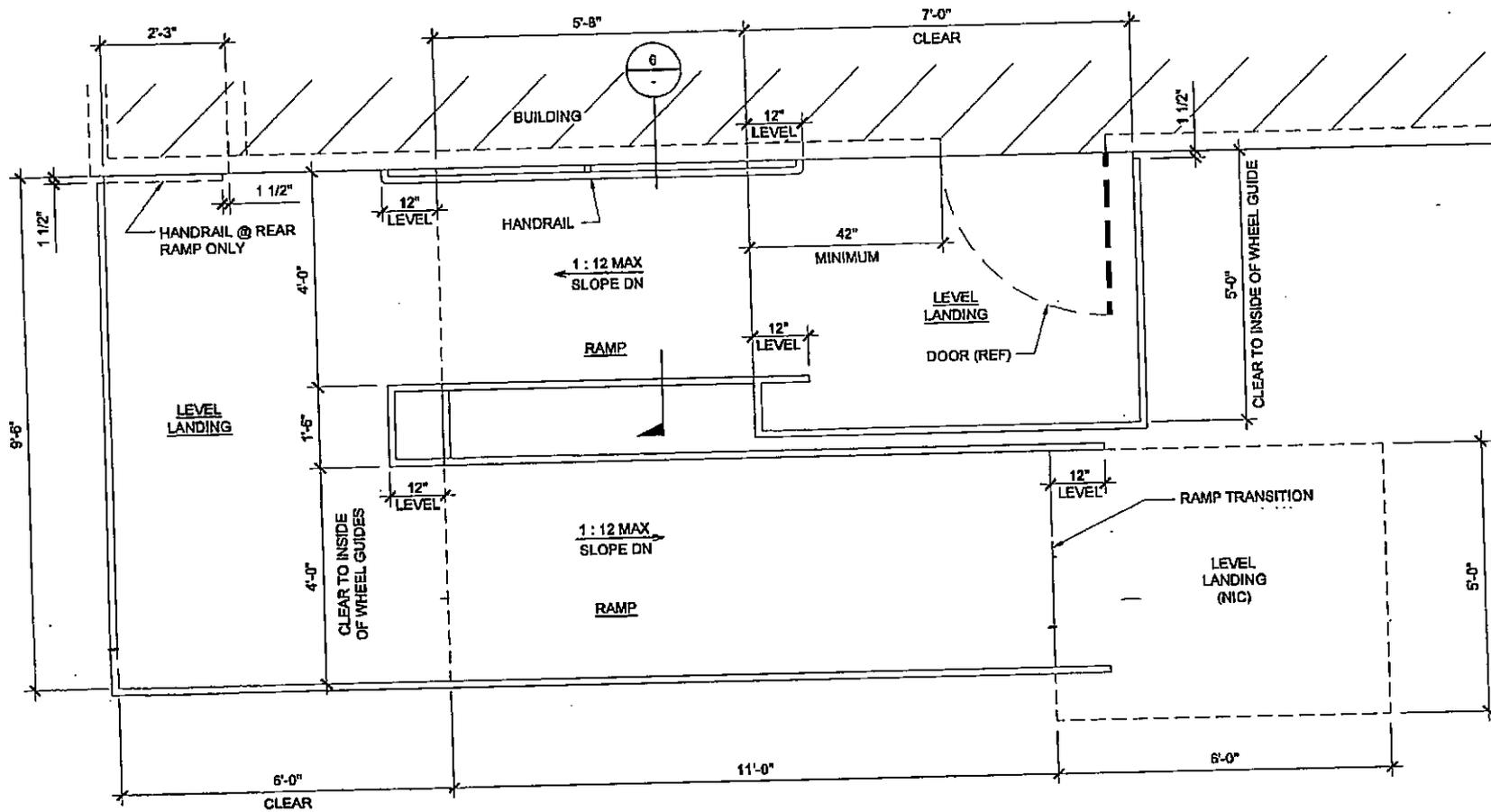

Switch Back Ramp

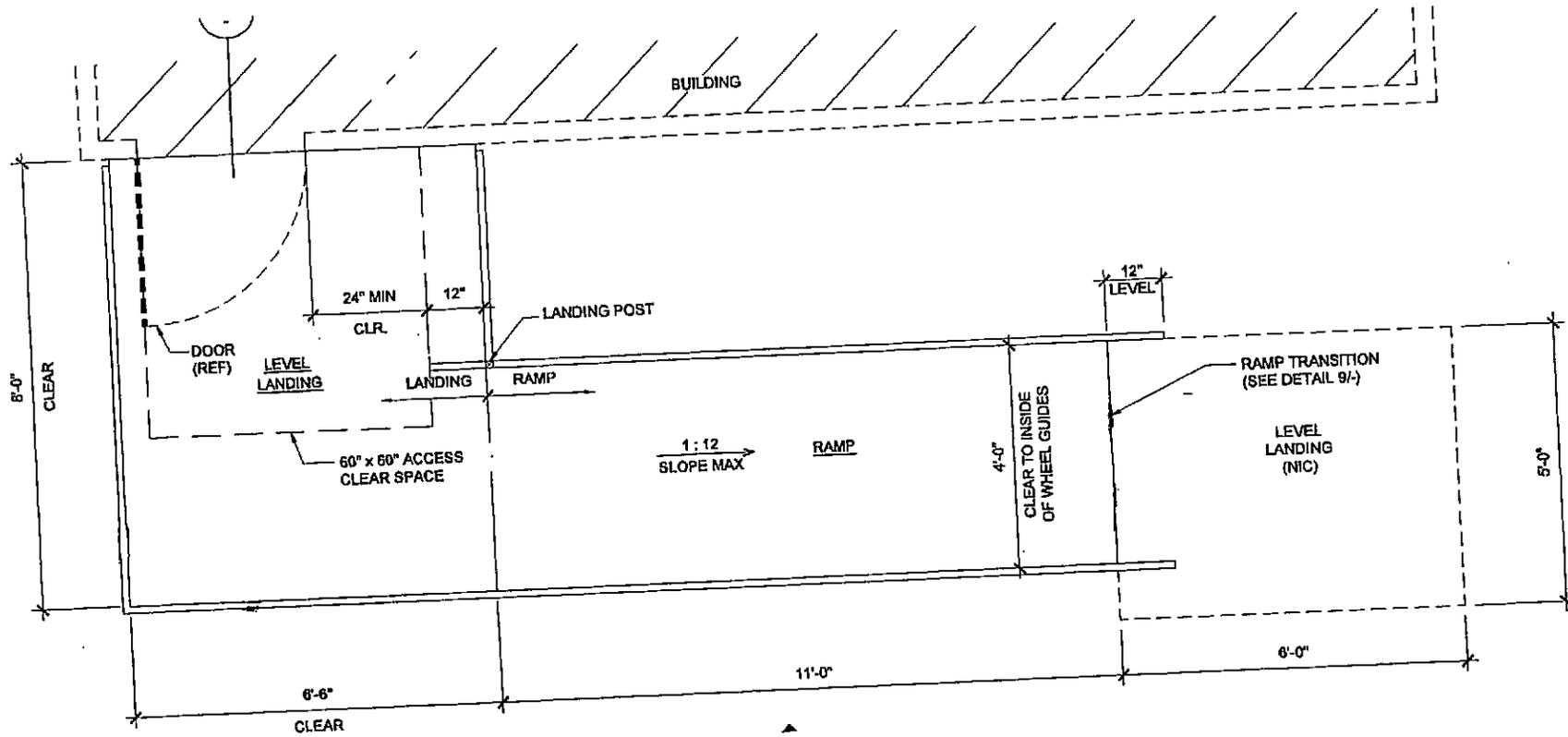

Offset Ramp

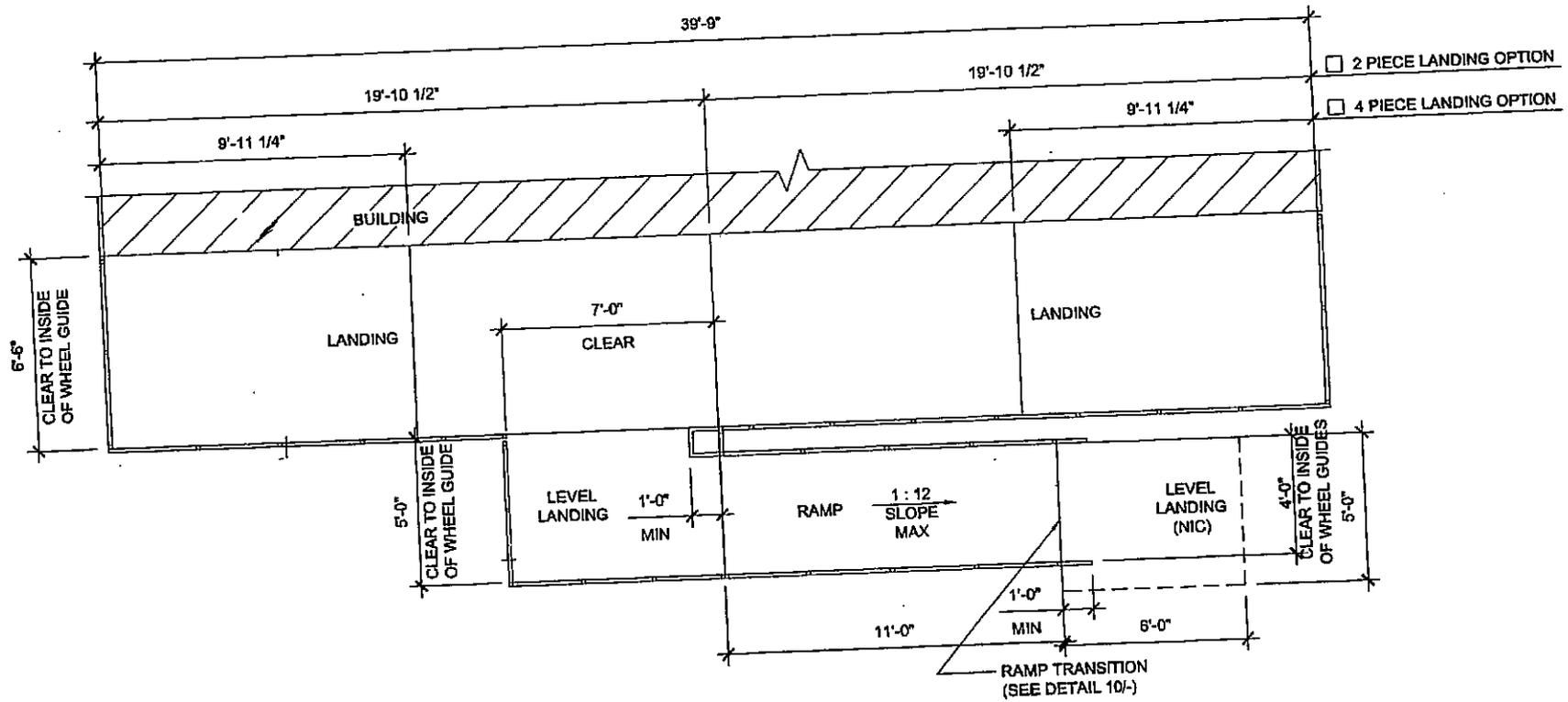

Common Deck with Ramp

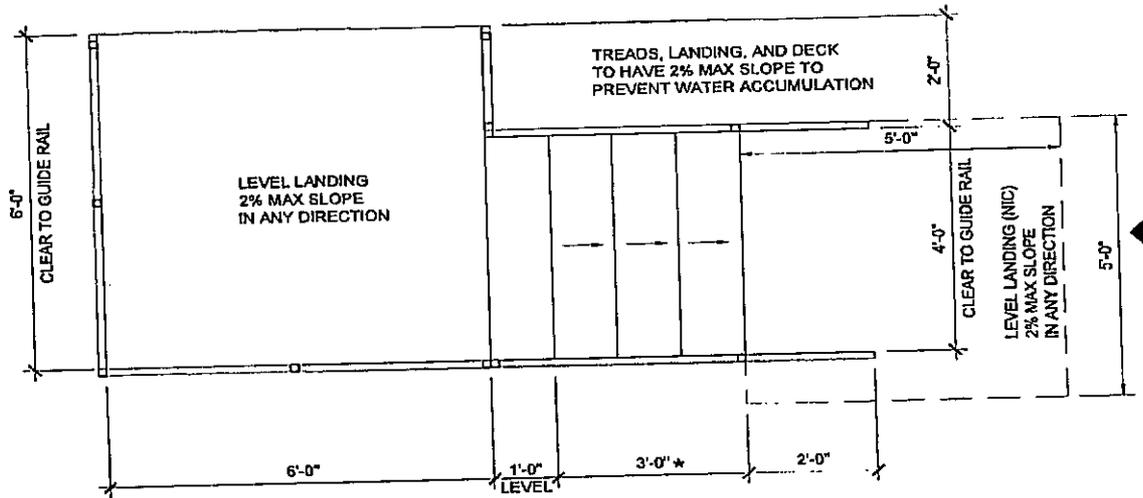

Landing and Steps

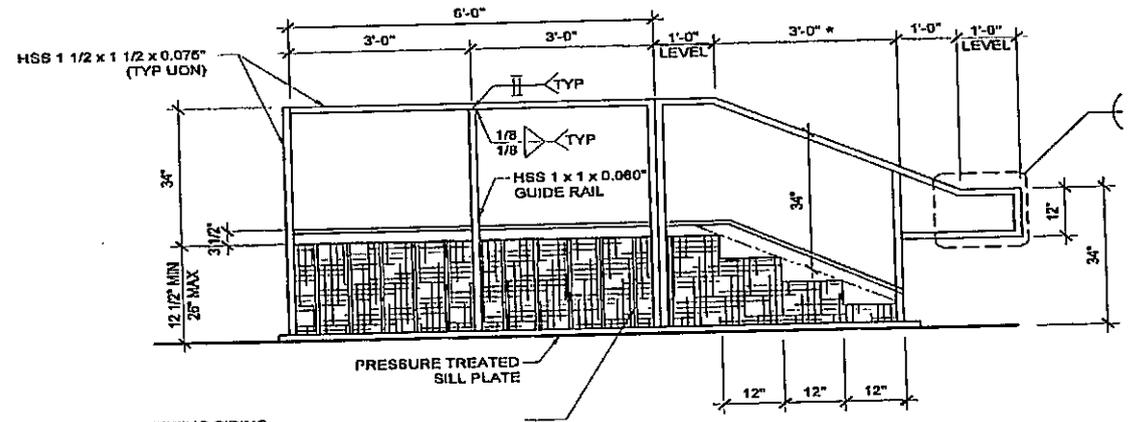

SKIRTING SIDING.
 BLOCK ALL EDGES. ATTACH WITH 4 8d AT 6" OC EN
 AND 12" OC FN. AT EDGE CONNECTION TO TUBE
 STEEL USE #14 x 2" TEK SCREWS AT 6" OC

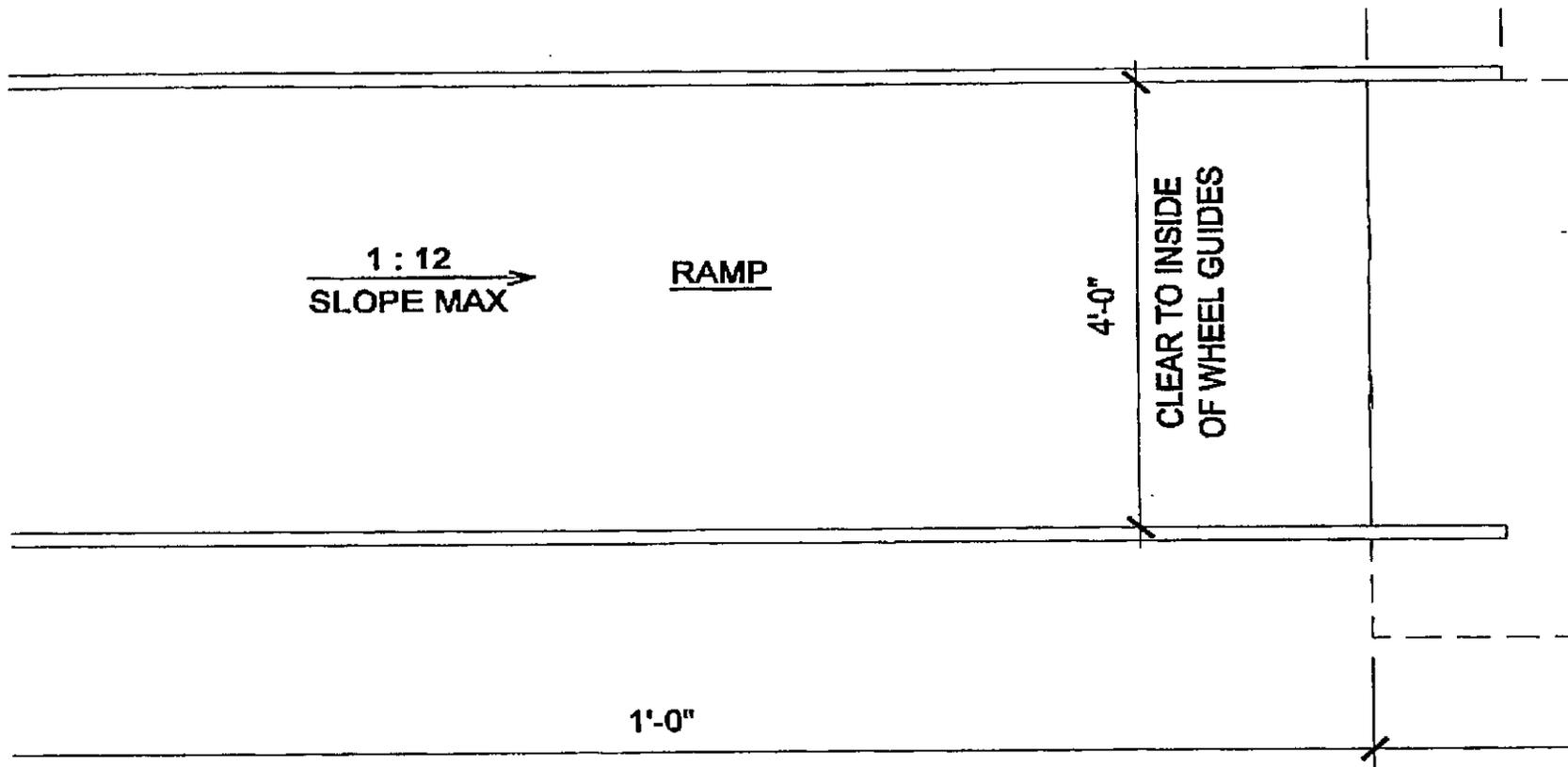

▲
Ramp Extension Per In.ft. – Offset from building
(Double Railing)

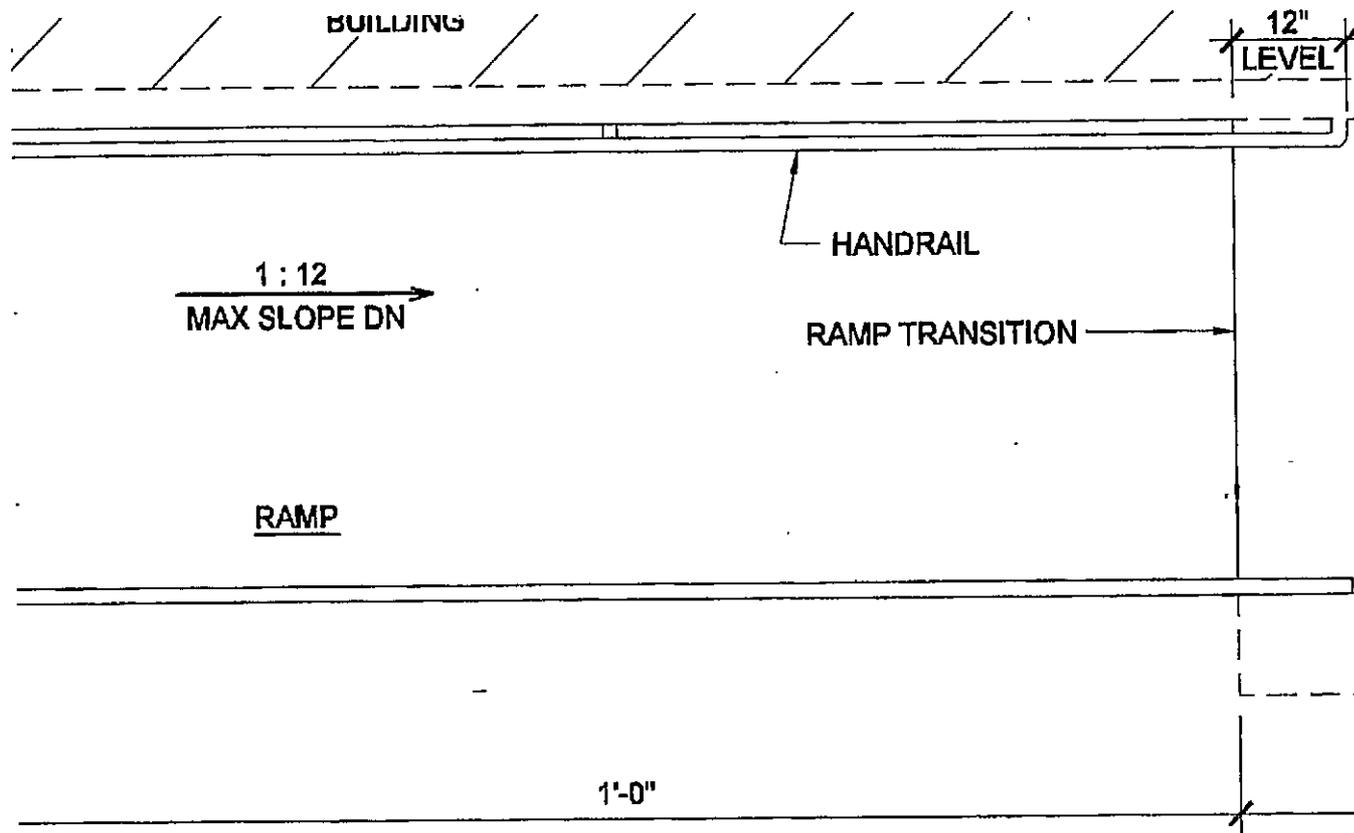

Ramp Extension Per In.ft. attached to building
(Single Railing)

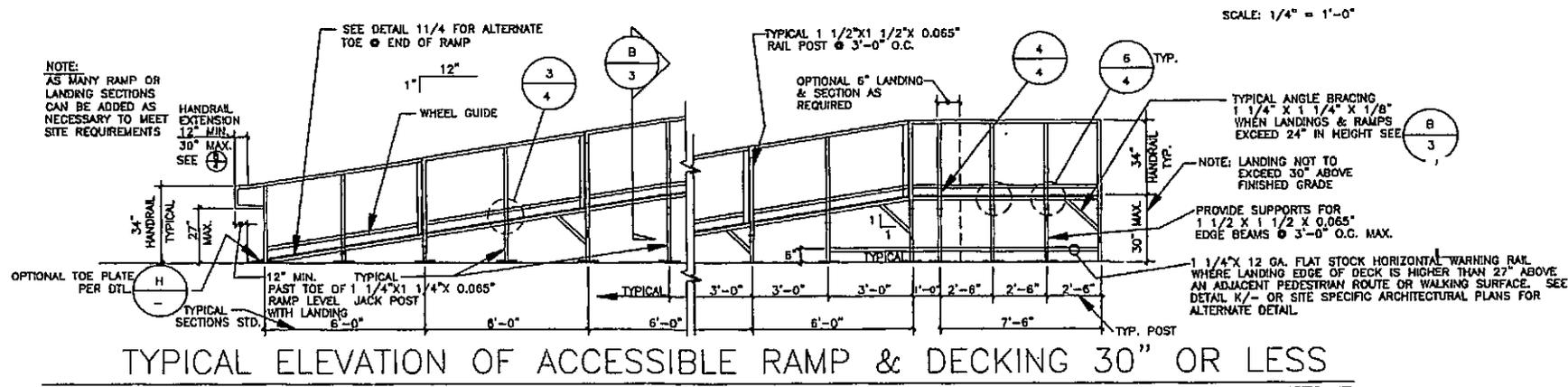

Below 30" Design Proposal

1. TMP Steal Ramp – per sq.ft priced
2. TMP Galvanized Aluminum – per sq.ft. priced
3. TMP Aluminum - per sq.ft. priced

TYPICAL PLAN VIEW OF ACCESSIBLE RAMP & DECK LAYOUT OVER 30" DESIGN

SCALE: 1/4" = 1'-0"

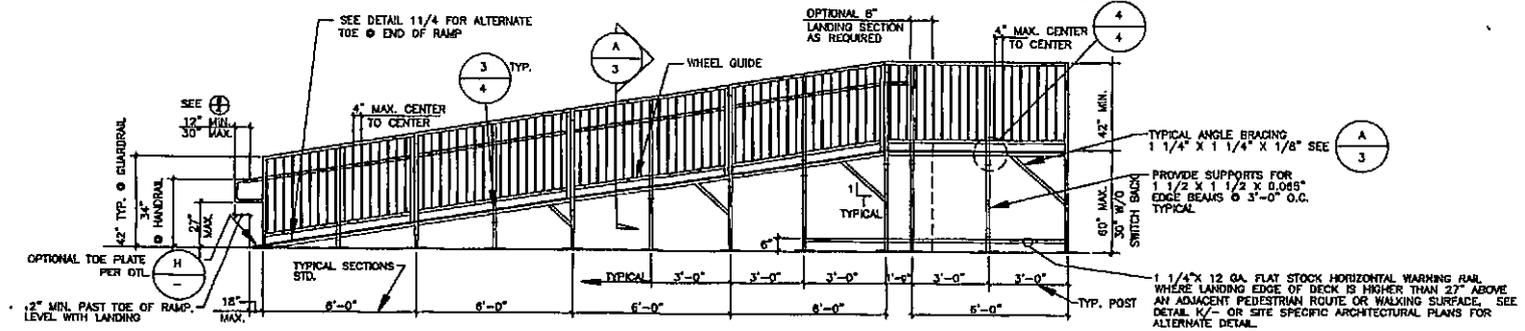

Over 30" Design Proposal

1. TMP Steal Ramp – per sq.ft priced
2. TMP Galvanized Aluminum – per sq.ft. priced
3. TMP Aluminum - per sq.ft. priced

CLOSURE BETWEEN BUILDINGS

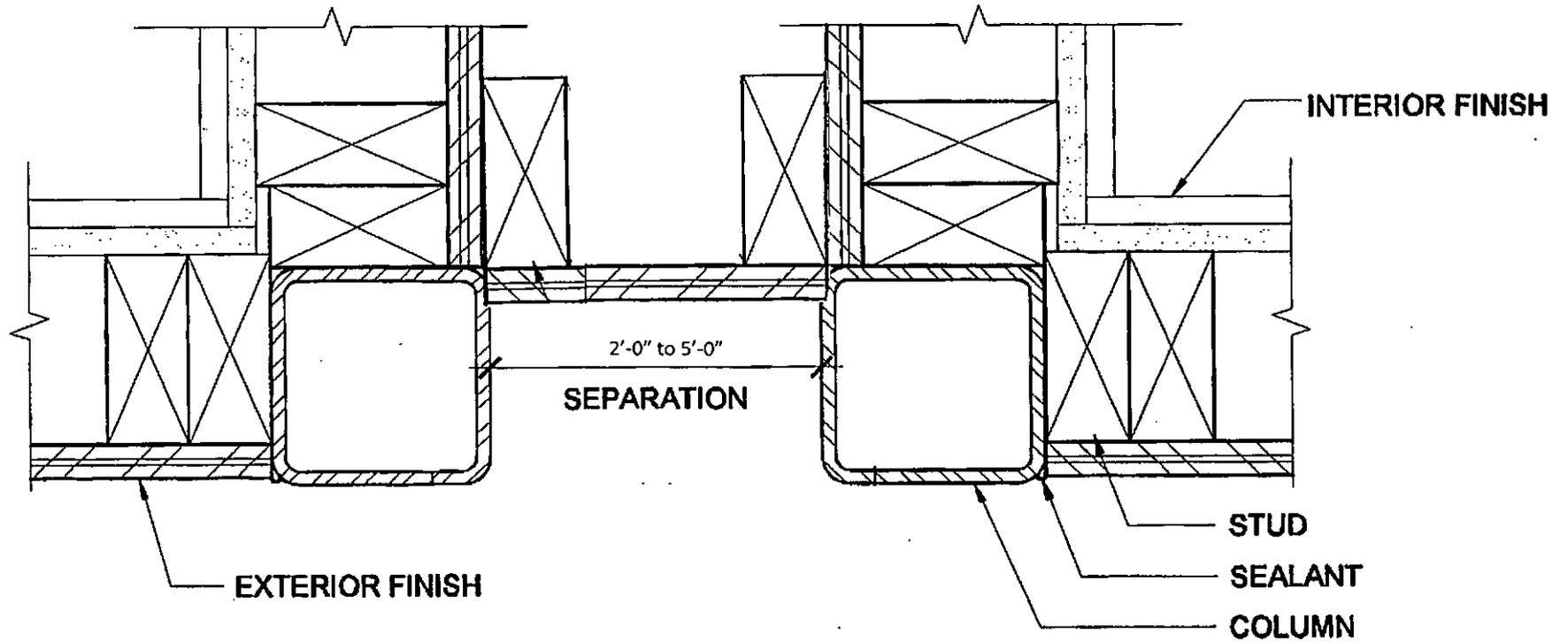

Pricing per 2'-0" section

Pricing per 5'-0" section

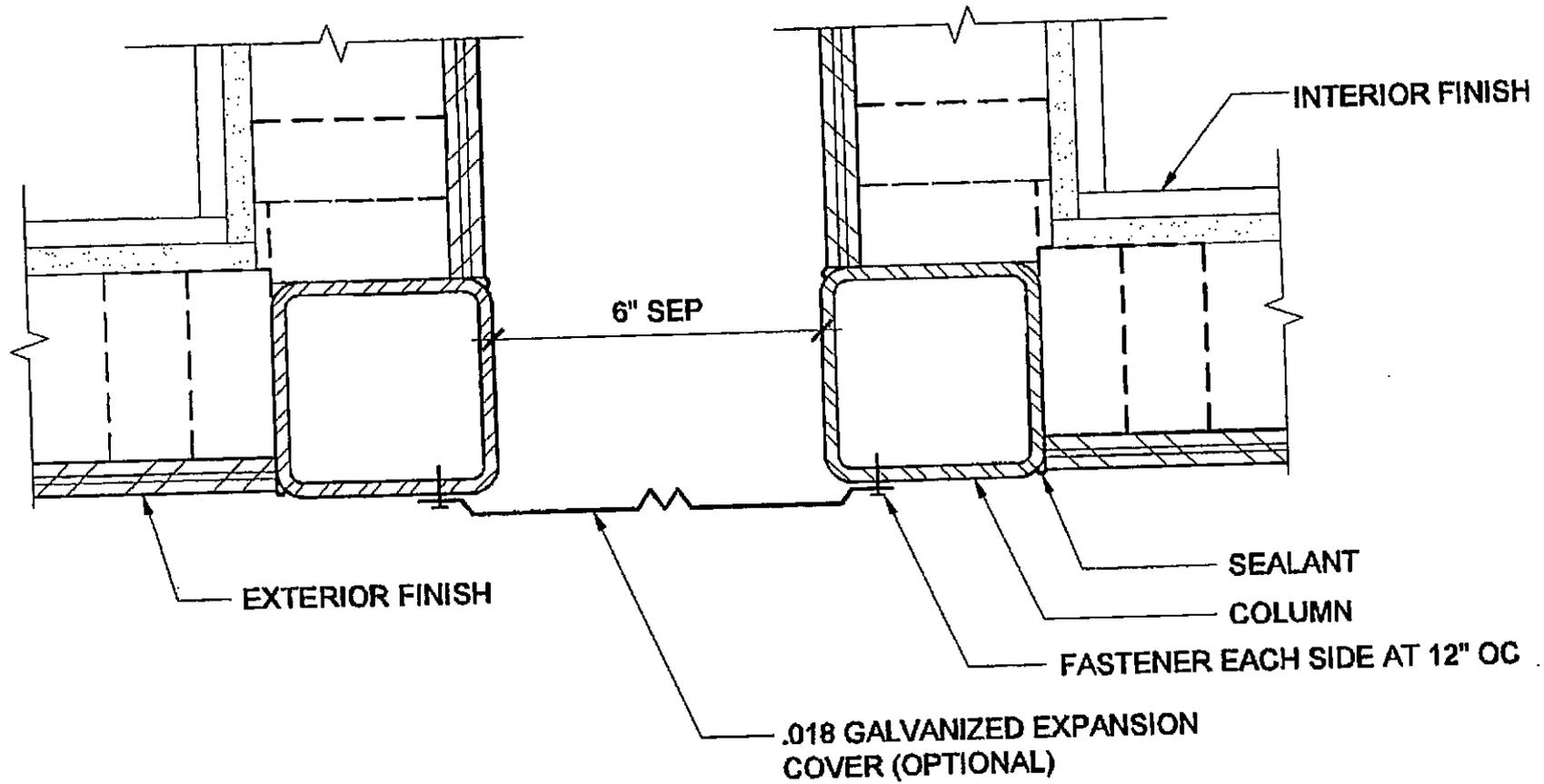

6" separation expansion cover at face of building

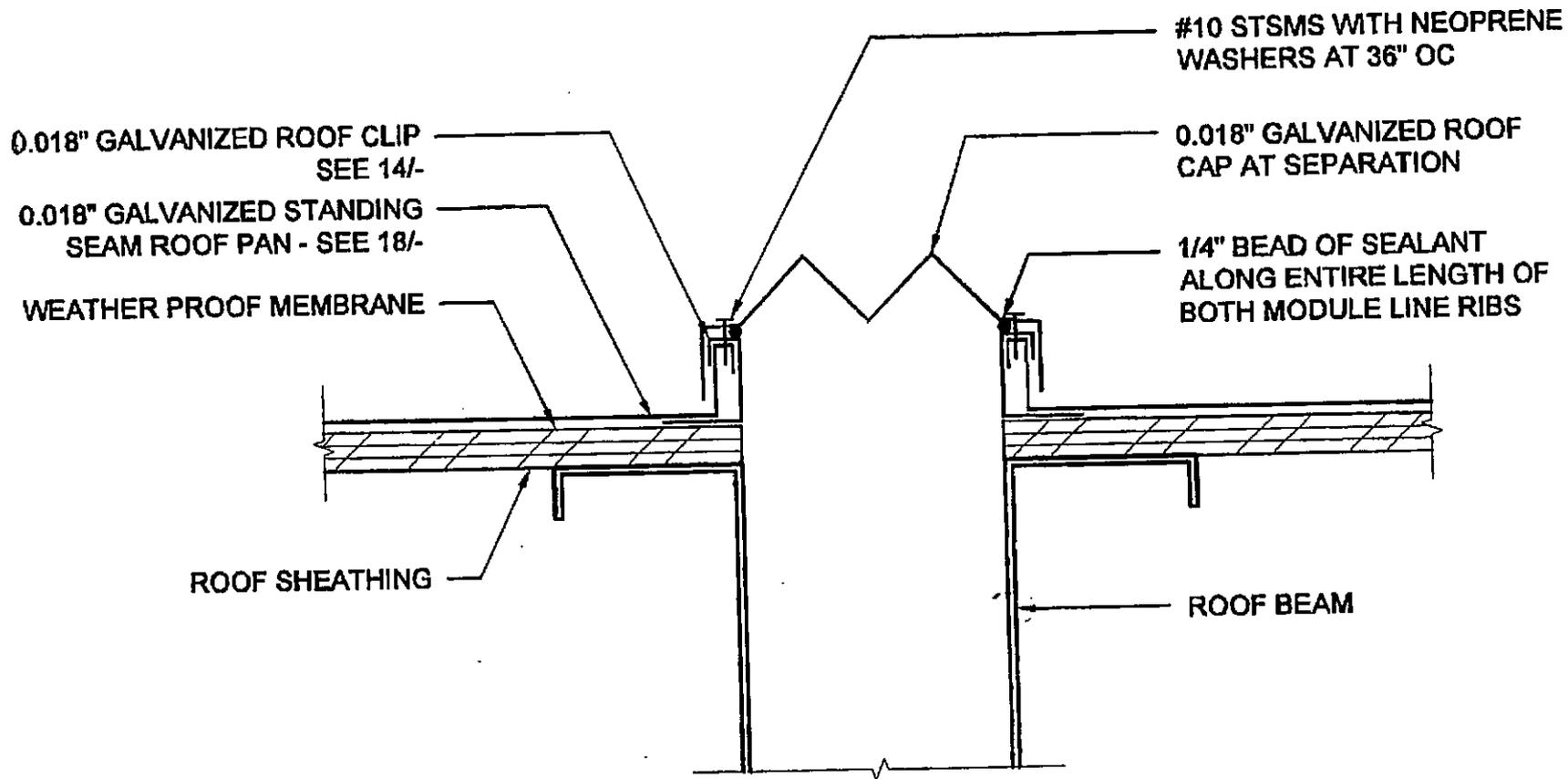

6" separation expansion cover at roof

INFORMATION REQUIRED OF BIDDER

The Bidder shall furnish all the following information. Bidder shall carefully read and answer all questions to ensure completeness and accuracy. Failure to comply with this requirement may cause rejection of the bid. Additional sheets may be attached if necessary. "You" or "your" as used herein refers to the bidder and any of its owners, officers, directors, shareholders, principals, responsible managing officer (RMO) or responsible managing employee (RME). District has discretion to request additional information.

- (1) Bidder name and address (Post Office Box Number not sufficient):

- (2) Telephone: _____ Fax No.: _____
Electronic Mail: _____

- (3) Individual ___ Partnership ___ Corporation ___ Joint Venture ___ (check one)

- (4) Bidder's License No. _____ Class: _____
License Expiration Date _____
Name of License holder _____

- (5) Have you ever been licensed under a different name or different license number?
Yes ___ No ___ If "Yes," give name and license number.

- (6) Names and titles of all your owners, officers, principals, responsible managing officers and responsible managing employees:

Name	Title
_____	_____
_____	_____
_____	_____

- (7) Number of years as a provider of relocatable modular buildings: _____ years
- (8) Number of years as an installer/remover/servicer of relocatable modular buildings:
_____ years
- (9) Are you currently engaged in or have you provided relocatable modular buildings and related services under contract with a school district or county superintendent of schools?
Yes _____ No _____

If yes: a. Name of agency: _____
 b. Address: _____
 c. Telephone Number: _____
 d. Contact Person: _____
 e. Name of your current terminal or location manager: _____
 f. Length of manager's service at location: _____
 g. Types of service you provide at location: _____
 h. Number of buses/vehicles utilized per location: _____
 i. Beginning and ending dates of current contracts: _____

- (10) List all applicable permits (City, County, and State) under which you currently operate your company:

- (11) Do you require all employees to undergo random drug testing?

Yes _____ No _____ If yes, please explain your company policies and procedures

- (12) Does your company fingerprint all employees, drivers, attendants and mechanics who might come in contact with students?

Yes _____ No _____

- (13) Do you conduct criminal background checks on all employees, drivers, attendants and mechanics who might come in contact with students?

Yes _____ No _____
(14) Provide the total of job or work related injuries you suffered within the State of California, in the past three (3) years. Please break down the numbers within categories of preventable or non-preventable. Give a brief description of what programs or training were instituted to ensure a non-reoccurrence of the injuries.

(15) Do you have a formal, scheduled preventive maintenance program for relocatable modular buildings?
Yes _____ No _____ If yes, provide details of the program and a sample of checklists.

(16) If requested, will you authorize your insurance carriers to furnish, in writing, your accident loss ratio and worker's compensation loss ratio for the past three (3) years within California?
Yes _____ No _____ If no, please explain: _____

(17) Have you ever been terminated from a school district or any public contract prior to the completion of the contract? Yes _____ No _____ If the answer is "Yes," give dates, names and addresses of school district/public agency and details.

(18) Have you ever been barred from bidding on any school district or public services contract? Yes _____ No _____ If the answer is "Yes," give dates, names and addresses of school district/public agency and details.

(19) Have you ever defaulted on any school district or public services contract? Yes ___ No ___
If the answer is "Yes," give dates, names and addresses of school district/public agency and details.

(20) Have you ever brought any claim(s) against a school district or public agency? Yes ___ No ___
If the answer is "Yes," please explain in detail name of school district/public agency, nature of the claim and outcome.

(21) Have you been in litigation or arbitration or dispute of any kind on a question or questions relating to a school district or services contract during the past ten (10) years? Yes ___ No ___
If the answer is "Yes," provide name of the school district/public agency and details.

(22) Do you now or have you ever had any direct or indirect business, financial or other connection with any officer, employee or consultant of the District? Yes ___ No ___
If so, please elaborate.

(23) List at least five (5) of your most recent school district contracts.

- (1) _____
- (2) _____
- (3) _____
- (4) _____
- (5) _____

(24) Are you currently providing relocatable modular buildings under another contract?

Yes ___ No ___ If the answer is "Yes," please provide the following information:

(a) Name of Contract: _____

Detailed Description: _____

Name of Contract Owner: _____

Contract Amount: _____

Completion Date: _____

(b) Name of Contract: _____

Detailed Description: _____

Name of Contract Owner: _____

Contract Amount: _____

Completion Date: _____

(c) Name of Contract: _____

Detailed Description: _____

Name of Contract Owner: _____

Contract Amount: _____

Completion Date: _____

(d) Name of Contract: _____

Detailed Description: _____

Name of Contract Owner: _____

Contract Amount: _____

Completion Date: _____

(e) Name of Contract: _____

Detailed Description: _____

Name of Contract Owner: _____

Contract Amount: _____

Completion Date: _____

(25) Are there relocatable modular contracts not listed above that will be undertaken during the duration of District's contract? Yes _____ No _____ If the answer is "Yes," please provide the following information:

(a) Name of Contract: _____

Detailed Description: _____

Name of Contract Owner: _____

Contract Amount: _____

Completion Date: _____

(b) Name of Contract: _____

Detailed Description: _____

Name of Contract Owner: _____

Contract Amount: _____

Completion Date: _____

(c) Name of Contract: _____

Detailed Description: _____

Name of Contract Owner: _____

Contract Amount: _____

Completion Date: _____

(26) List of References – Public/school district contracts references within the last five (5) years. District has discretion to require more than five (5) references.

1. Name: _____
Address and Telephone: _____

Contact Person: _____
Description of Contract: _____
Dates of commencement and completion of Contract: _____

Contract Amount: _____

2. Name: _____
Address and Telephone: _____

Contact Person: _____
Description of Contract: _____
Dates of commencement and completion of Contract: _____

Contract Amount: _____

3. Name: _____
Address and Telephone: _____

Contact Person: _____
Description of Contract: _____
Dates of commencement and completion of Contract: _____

Contract Amount: _____

4. Name: _____
Address and Telephone: _____

Contact Person: _____

Description of Contract: _____

Dates of commencement and completion of Contract:

Contract Amount: _____

5. Name: _____

Address and Telephone: _____

Contact Person: _____

Description of Contract: _____

Dates of commencement and completion of Contract: _____

Contract Amount: _____

(47) Additional
information: _____

I certify and declare under penalty of perjury under the laws of the State of California that the foregoing responses to the Information Required of Bidder are true and correct.

Signature

Print Name

Title

Date

**NON-COLLUSION DECLARATION TO BE EXECUTED BY
BIDDER AND SUBMITTED WITH BID**

The undersigned declares:

I am the _____ of _____, the party making the foregoing bid.

The bid is not made in the interest of, or on behalf of, any undisclosed person, partnership, company, association, organization, or corporation. The bid is genuine and not collusive or sham. The bidder has not directly or indirectly induced or solicited any other bidder to put in a false or sham bid. The bidder has not directly or indirectly colluded, conspired, connived, or agreed with any bidder or anyone else to put in a sham bid, or to refrain from bidding. The bidder has not in any manner, directly or indirectly, sought by agreement, communication, or conference with anyone to fix the bid price of the bidder or any other bidder, or to fix any overhead, profit, or cost element of the bid price, or of that of any other bidder. All statements contained in the bid are true. The bidder has not, directly or indirectly, submitted his or her bid price or any breakdown thereof, or the contents thereof, or divulged information or data relative thereto, to any corporation, partnership, company, association, organization, bid depository, or to any member or agent thereof, to effectuate a collusive or sham bid, and has not paid, and will not pay, any person or entity for such purpose.

Any person executing this declaration on behalf of a bidder that is a corporation, partnership, joint venture, limited liability company, limited liability partnership, or any other entity, hereby represents that he or she has full power to execute, and does execute, this declaration on behalf of the bidder.

I declare under penalty of perjury under the laws of the State of California that the foregoing is true and correct and that this declaration is executed on _____ [date], at _____ [city], _____ [state].

Signature

Print Name

Title

WORKERS' COMPENSATION CERTIFICATE

Labor Code Section 3700.

"Every employer except the state shall secure the payment of compensation in one or more of the following ways:

(a) By being insured against liability to pay compensation in one or more insurers duly authorized to write compensation insurance in this state.

(b) By securing from the Director of Industrial Relations a certificate of consent to self-insure either as an individual employer or as one employer in a group of employers, which may be given upon furnishing proof satisfactory to the Director of Industrial Relations of ability to self-insure and to pay any compensation that may become due to his or her employees.

(c) For any county, city, city and county, municipal corporation, public district, public agency or any political subdivision of the state, including each member of a pooling arrangement under a joint exercise of powers agreement (but not the state itself), by securing from the Director of Industrial Relations a certificate of consent to self-insure against workers' compensation claims, which certificate may be given upon furnishing proof satisfactory to the director of ability to administer workers' compensation claims properly, and to pay workers' compensation claims that may become due to its employees. On or before March 31, 1979, a political subdivision of the state which, on December 31, 1978, was uninsured for its liability to pay compensation, shall file a properly completed and executed application for a certificate of consent to self-insure against workers' compensation claims. The certificate shall be issued and be subject to the provisions of Section 3702."

I am aware of the provisions of Labor Code Section 3700 which require every employer to be insured against liability for workers' compensation or to undertake self-insurance in accordance with the provisions of that code, and I will comply with such provisions before commencing the performance of the work of this contract.

Name of Contractor

By: _____
Signature

Print Name

Title

Date

(In accordance with Article 5 [commencing at Section 1860], Chapter 1, Part 7, Division 2 of the Labor Code, the above certificate must be signed and filed with the awarding body prior to performing any work under the contract.)

AGREEMENT

THIS AGREEMENT, dated the ____ day of _____, 20__, in the County of Orange, State of California, is by and between the Garden Grove Unified School District (hereinafter referred to as "District"), and _____, (hereinafter referred to as "Contractor").

The District and the Contractor, for the consideration stated herein, agree as follows:

1. Contractor agrees to provide and complete the **District-wide Rental and/or Purchase of Relocatable Modular Buildings Bid No. 1512** according to all the terms and conditions set forth in the Bid Documents, including but not limited to the Notice Calling For Bids, Bid Objective, Information for Bidders, Bid Form including Price Sheet and Attachments A through E (the Bid Form Matrix), Information Required of Bidder, Non-collusion Declaration, Workers' Compensation Certificate, Drug-Free Workplace Certification, Criminal Records Check Certification, Tobacco Use Policy Certification, Insurance Certificates and Endorsements, General Conditions, Special Conditions, and all modifications, addenda and amendments thereto by this reference incorporated herein. The Bid Documents are complementary, and what is called for by any one shall be as binding as if called for by all.

2. Contractor shall provide and complete performance within the time set forth in Paragraph 4 of this Agreement – and from time-to-time at the District's sole discretion during the term of this Agreement - everything required to be performed, and shall provide, furnish and pay for all the labor, materials, necessary tools, expendable equipment, and all taxes and utility services required for performance of the services. All of said services shall be performed and completed in a good workmanlike manner in strict accordance with all provisions of this Agreement as hereinabove defined and in accordance with applicable laws, codes, regulations, ordinances and any other legal requirements governing the services. The Contractor shall be liable to the District for any damages arising as a result of a failure to fully comply with this obligation.

3. District shall pay to the Contractor, as full consideration for the faithful performance of this Agreement, subject to any additions or deductions as provided in the Bid Documents, the prices set forth on the Bid Form Price Sheet and Bid Form Matrix.

Prices. - Pricing shall be inclusive of any and all cost charged to the District including incidental service charges for delivery, setup, dismantling and return, taxes and fuel surcharges as indicated in the Bid Matrix Form. The prices may be adjusted annually after the first year beginning in January, 2017. In the event the successful bidder proposed to increase or decrease the rates for the installation, delivery, return and knockdown services, the successful bidder shall provide the District with a written proposal on or before January 1 of each year. The price adjustment shall be calculated as follows: The original contract price, multiplied by the Office of Public School Construction Class B index, ending the month prior to the annual adjustment (i.e. December of the year immediately preceding the adjustment).

Freight/shipping charges that may be required by other agencies piggybacking off this contract are outside the scope of the base bid. Furthermore, additional charges due to site

conditions or labor rates at other agencies piggybacking off his bid are also outside the scope of the base bid.

4. The services shall be commenced on or before the fifth (5) day after receiving the District's Notice to Proceed. The term of this Agreement shall be a three (3) year period, July 1, 2016 through June 30, 2019.

5. **Time is of the essence.**

6. Termination for Cause or Non-appropriation. In the event Contractor defaults in the performance of the Agreement as set forth in General Conditions or if there is a non-appropriation of funds or insufficient funds as set forth in General Conditions, then this Agreement shall terminate or be suspended as set forth in General Conditions.

7. Termination for Convenience. District has discretion to terminate this Agreement at any time and require Contractor to cease all services by providing Contractor written notice of termination specifying the desired date of termination. Upon receipt of written notice from District of such termination for District's convenience, Contractor shall:

- (i) Cease operations as directed by District in the notice;
- (ii) Take any actions necessary, or that District may direct, for the protection and preservation of the work; and
- (iii) Not terminate any insurance provisions required by the Bid Documents.

In case of such termination for District's convenience, Contractor shall be entitled to receive payment from District for services satisfactorily performed. The foregoing provisions are in addition to and not in limitation of any other rights or remedies available to the District.

8. The Contractor agrees to and does hereby indemnify and hold harmless the District, its Governing Board, officers, agents, and employees from every claim or demand made, and every liability, loss, damage, or expense, of any nature whatsoever, which may be incurred by reason of:

(a) Any injury to or death of any person(s) or damage to, loss or theft of any property sustained by the Contractor or any person, firm or corporation employed by the Contractor, either directly or by independent contract, upon or in connection with the work called for in this Agreement, except for liability resulting from the sole active negligence, or willful misconduct of the District.

(b) Any injury to or death of any person(s) or damage, loss or theft of any property caused by any act, neglect, default or omission of the Contractor, or any person, firm, or corporation employed by the Contractor, either directly or by independent contract, arising out of, or in any way connected with the work covered by this Agreement, whether said injury or damage occurs either on or off District's property, if the liability arose due to the negligence or willful misconduct of anyone employed by the Contractor, either directly or by independent contract,

The Contractor, at Contractor's own expense, cost, and risk shall defend any and all actions, suits, or other proceedings that may be brought or instituted against the District, its Governing Board, officers, agents or employees, on any such claim, demand or liability, and shall pay or satisfy any judgment that may be rendered against the District, its Governing Board, officers, agents or employees in any action, suit or other proceedings as a result thereof.

9. Hold Harmless and Indemnification. To the fullest extent permitted by law, the Contractor, at the Contractor's sole cost and expense, agrees to fully defend, indemnify and hold harmless, the District, including but not limited to any of its Governing Board members, officers, employees and agents, from and against any and all claims, actions, demands, costs, judgments, liens, penalties, liabilities, damages, losses, anticipated losses of revenues, and expenses, including any fees of accountants, attorneys or other professionals, arising out of, in connection with, resulting from or related to, or claimed to be arising out of, in connection with, resulting from or related to any act or omission by the Contractor or any of its officers, agents, employees, any person performing any of the services pursuant to a direct or indirect contract with the Contractor or individual entities comprising the Contractor, in connection with or relating to, or claimed to be in connection with or relating to the services or this Agreement, including but not limited to any costs or liabilities arising out of or in connection with:

- (a) failure to comply with any applicable law, statute, code, ordinance, regulation, permit or orders;
- (b) any misrepresentation, misstatement or omission with respect to any statement made in the Bid Documents or any document furnished by the Contractor in connection therewith;
- (c) any breach of duty, obligation or requirement under the Bid Documents;
- (d) any failure to provide notice to any party as required under the Bid Documents; or
- (e) any failure to act in such a manner as to protect the District from loss, cost, expense or liability.

This indemnity shall survive termination of the contract or final payment thereunder. This indemnity is in addition to any other rights or remedies which the District may have under the law or under the Bid Documents. In the event of any claim or demand made against any party which is entitled to be indemnified hereunder, the District may in its sole discretion reserve, retain or apply any monies due to the Contractor under the Bid Documents for the purpose of resolving such claims; provided, however, that the District may release such funds if the Contractor provides the District with reasonable assurance of protection of the District's interests. The District shall in their sole discretion determine whether such assurances are reasonable.

10. Contractor shall take out, prior to commencing the services, and maintain, during the life of this Agreement, the insurance coverages set forth in the Information for Bidders.

11. If Contractor is a corporation, the undersigned hereby represents and warrants that the corporation is duly incorporated and in good standing in the State of _____, and that

_____, whose title is _____, is authorized to act for and bind the corporation.

12. Each and every provision of law and clause required by law to be inserted in this Agreement shall be deemed to be inserted herein and the Agreement shall be read and enforced as though it were included herein, and if through mistake or otherwise any such provision is not inserted, or is not currently inserted, then upon application of either party the Agreement shall forthwith be physically amended to make such insertion or correction.

13. This Agreement constitutes the entire agreement of the parties. No other agreements, oral or written, pertaining to the work to be performed, exists between the parties. This Agreement can be modified only by an amendment in writing, signed by both parties and pursuant to action of the Governing Board of the District. This Agreement shall be governed by the laws of the State of California.

14. Piggyback/Other Public Agencies. Pursuant to Public Contract Code Sections 20118 and 20652 and other applicable provisions, other public agencies, including school districts and community colleges in the State of California, may acquire items identified in this Agreement under the same terms and conditions of this Agreement and the Project Documents. The District waives its rights for a warrant to be drawn in its favor or for any reasonable costs, and directs each public agency to work directly with the Contractor.

IN WITNESS WHEREOF, the parties hereto have caused this Agreement to be executed.

DISTRICT: GARDEN GROVE
UNIFIED SCHOOL DISTRICT

CONTRACTOR

By: _____
Signature

By: _____
Signature

Print Name

Print Name

Title

Title

Contractor's License No.

Tax ID/Social Security No.

(CORPORATE SEAL OF CONTRACTOR,
if corporation)

DRUG-FREE WORKPLACE CERTIFICATION

This Drug-Free Workplace Certification is required pursuant to Government Code Section 8350 et seq., the Drug-Free Workplace Act of 1990. The Drug-Free Workplace Act of 1990 requires that every person or organization awarded a contract for the procurement of any property or services from any State agency must certify that it will provide a drug-free workplace by doing certain specified acts. In addition, the Act provides that each contract awarded by a State agency may be subject to suspension of payments or termination of the contract, and the contractor may be subject to debarment from future contracting, if the state agency determines that specified acts have occurred.

Pursuant to Government Code Section 8355, every person or organization awarded a contract from a State agency shall certify that it will provide a drug-free workplace by doing all of the following:

a) publishing a statement notifying employees that the unlawful manufacture, distribution, dispensation, possession or use of a controlled substance is prohibited in the person's or organization's workplace and specifying actions which will be taken against employees for violations of the prohibition;

b) establishing a drug-free awareness program to inform employees about all of the following:

- 1) the dangers of drug abuse in the workplace;
- 2) the person's or organization's policy of maintaining a drug-free workplace;
- 3) the availability of drug counseling, rehabilitation and employee-assistance programs;
- 4) the penalties that may be imposed upon employees for drug abuse violations;

c) requiring that each employee engaged in the performance of the contract be given a copy of the statement required by subdivision (a) and that, as a condition of employment on the contract, the employee agrees to abide by the terms of the statement.

I, the undersigned, agree to fulfill the terms and requirements of Government Code Section 8355 listed above and will publish a statement notifying employees concerning (a) the prohibition of controlled substance at the workplace, (b) establishing a drug-free awareness program, and (c) requiring that each employee engaged in the performance of the contract be given a copy of the statement required by Section 8355(a) and requiring that the employee agree to abide by the terms of that statement.

I also understand that if the District determines that I have either (a) made a false certification herein, or (b) violated this certification by failing to carry out the requirements of Section 8355,

that the contract awarded herein is subject to suspension of payments, termination, or both. I further understand that, should I violate the terms of the Drug-Free Workplace Act of 1990, I may be subject to debarment in accordance with the requirements of Section 8350 et seq.

I acknowledge that I am aware of the provisions of Government Code Section 8350 et seq. and hereby certify that I will adhere to the requirements of the Drug-Free Workplace Act of 1990.

NAME OF CONTRACTOR

Signature

Print Name

Title

Date

NOTICE TO CONTRACTORS REGARDING CRIMINAL RECORDS CHECK
(EDUCATION CODE SECTION 45125.1)

Education Code Section 45125.1 provides that if the employees of any entity that has a contract with a school district may have any contact with pupils, those employees shall submit or have submitted their fingerprints in a manner authorized by the Department of Justice together with a fee determined by the Department of Justice to be sufficient to reimburse the Department for its costs incurred in processing the application.

The Department of Justice shall ascertain whether the individual whose fingerprints were submitted to it has been arrested or convicted of any crime insofar as that fact can be ascertained from information available to the Department. When the Department of Justice ascertains that an individual whose fingerprints were submitted to it has a pending criminal proceeding for a violent felony listed in Penal Code Section 1192.7(c), or has been convicted of such a felony, the Department shall notify the employer designated by the individual of the criminal information pertaining to the individual. The notification shall be delivered by telephone and shall be confirmed in writing and delivered to the employer by first-class mail.

The contractor shall not permit an employee to come in contact with pupils until the Department of Justice has ascertained that the employee has not been convicted of a violent or serious felony. The contractor shall certify in writing to the governing board of the school district that none of its employees who may come in contact with pupils have been convicted of a violent or serious felony.

Penal Code Section 667.5(c) lists the following "violent" felonies: murder; voluntary manslaughter; mayhem; rape; sodomy by force; oral copulation by force; lewd acts on a child under the age of 14 years; any felony punishable by death or imprisonment in the state prison for life; any felony in which the defendant inflicts great bodily injury on another; any robbery perpetrated in an inhabited dwelling; arson; penetration of a person's genital or anal openings by foreign or unknown objects against the victim's will; attempted murder; explosion or attempt to explode or ignite a destructive device or explosive with the intent to commit murder; kidnapping; continuous sexual abuse of a child; and carjacking.

Penal Code Section 1192.7 lists the following "serious" felonies: murder; voluntary manslaughter; mayhem; rape; sodomy by force; oral copulation by force; a lewd or lascivious act on a child under the age of 14 years; any felony punishable by death or imprisonment in the state prison for life; any felony in which the defendant personally inflicts great bodily injury on another, or in which the defendant personally uses a firearm; attempted murder; assault with intent to commit rape or robbery; assault with a deadly weapon on a peace officer; assault by a life prisoner on a noninmate; assault with a deadly weapon by an inmate; arson; exploding a destructive device with intent to injure or to murder, or explosion causing great bodily injury or mayhem; burglary of an inhabited dwelling; robbery or bank robbery; kidnapping; holding of a hostage by a person confined in a state prison; attempt to commit a felony punishable by death or imprisonment in the state prison for life; any felony in which the defendant personally uses a dangerous or deadly weapon; selling or furnishing specified controlled substances to a minor; penetration of genital or anal openings by foreign objects against the victim's will; grand theft involving a firearm; carjacking; and a conspiracy to commit specified controlled substances offenses.

CERTIFICATION BY CONTRACTOR
CRIMINAL RECORDS CHECK
AB 1610, 1612 and 2102

To the Governing Board of Garden Grove Unified School District:

I, _____ certify that:
Name of Transportation Contractor

1. I have carefully read and understand the Notice to Contractors Regarding Criminal Record Checks (Education Code Section 45125.1) required by the passage of AB 1610, 1612 and 2102.
2. Due to the nature of the work I will be performing for the District, my employees may have contact with students of the District.
3. None of the employees who will be performing the work have been convicted of a violent or serious felony as defined in the Notice and in Penal Code Section 1192.7 and this determination was made by a fingerprint check through the Department of Justice.

I declare under penalty of perjury that the foregoing is true and correct.

Executed at _____, California on _____.
Date

Signature

Typed or printed name

Title

Address

Telephone

TOBACCO USE POLICY CERTIFICATION

In the interest of public health, the Garden Grove Unified School District provides a tobacco-free environment. Smoking or the use of any tobacco products are prohibited in buildings and vehicles, and on any property owned, leased or contracted for, by the District. Failure to abide with this requirement could result in the termination of the contract.

I acknowledge that I am aware of Tobacco Use Policy and hereby certify that I and my employees will adhere to the requirements of the policy.

Name of Contractor

Signature

Date

SPECIAL CONDITIONS

SPECIAL CONDITIONS

Successful vendors shall have an assigned Account Representative available to the District during District working hours of 7:00 AM through 5:00 PM, Mondays through Fridays. The District prefers a single point of contact for ordering and/or other issues.

Responding vendors shall offer repair work to be corrected within three (3) hours. All service response time shall be within twenty-four (24) hours.

Modular/portable buildings purchased must be painted to match existing school colors. Contractor may choose to paint buildings at either off-site locations or on-site. If on-site painting and preparation is done, prevailing wage costs must be paid.

Repair and warranty support shall be available to the District twenty-four (24) hours per day.

All on-site labor is subject to prevailing wage. District has ascertained the general prevailing rate of per diem wages in the locality in which this work is to be performed for each craft or type of worker is needed to execute this contract. These rates are on file at the District's office, and a copy may be obtained upon request. A copy of these rates shall be posted at the job site. The schedule of per diem wages is based upon a working day of eight hours. The rate for holiday and overtime work shall be at least time and one-half.

No cleaning fee upon return of modular classrooms to awarded vendor.

All permits shall be included in bid prices.

Contractors must:

1. Agree to be paid for services based upon the costs set forth on the Bid Form Price Sheet. GGUSD will not be charged for any delays due to contractor's equipment failure or driver performance. There shall be no waiting time charge, no cancellation of trip charge.
2. For rental contracts, invoices must include documents specific to provided services that contain Purchase Order Number, Modular I.D., Location, Date(s) of Service, Trip Mileage, and Mileage Costs.
3. Partner with GGUSD to establish:
 - a) Operating procedures for maintaining ongoing communication with GGUSD.
 - b) Identify evaluation procedures and criteria for meeting District needs.
4. Understand and agree that any contract awarded by GGUSD will be non-exclusive, contingent on adequate funding and that any awarded contract may be terminated at any time by GGUSD.

GENERAL CONDITIONS

DOCUMENT 00 70 00

TABLE OF CONTENTS

GENERAL CONDITIONS

1. CONTRACT TERMS AND DEFINITIONS..... 1

1.1. Definitions 1

1.2. Laws Concerning the Contract 5

1.3. No Oral Agreements..... 5

1.4. No Assignment 5

1.5. Notice And Service Thereof..... 5

1.6. No Waiver 5

1.7. Substitutions for Specified Items 5

1.8. Materials and Work 5

2. DISTRICT 7

3. ARCHITECT 7

4. CONSTRUCTION MANAGER 7

5. INSPECTOR, INSPECTIONS AND TESTS 8

5.1. Project Inspector 8

5.2. Tests and Inspections 8

5.3. Costs for After Hours and/or Off Site Inspections 9

6. CONTRACTOR..... 9

6.1. Status of Contractor 9

6.2. Contractor’s Supervision 9

6.3. Duty to Provide Fit Workers 10

6.4. Personnel 11

6.5. Purchase of Materials and Equipment 11

6.6. Documents on Work 12

6.7. Preservation of Records 13

6.8. Integration of Work 13

6.9. Obtaining of Permits and Licenses 13

6.10. Work to Comply with Applicable Laws and Regulations 13

6.11. Safety/Protection of Persons and Property 14

6.12. Working Evenings and Weekends 16

6.13. Cleaning Up 16

7. SUBCONTRACTORS 17

8. OTHER CONTRACTS/CONTRACTORS 18

9.	DRAWINGS AND SPECIFICATIONS	18
9.8.	Ownership of Drawings	19
10.	CONTRACTOR'S SUBMITTALS AND SCHEDULES	19
10.1.	Schedules, Safety Plan and Complete Subcontractor List.....	19
10.2.	Monthly Progress Schedule(s).....	22
10.3.	Material Safety Data Sheets (MSDS).....	22
10.4.	Logistic Plan.....	22
11.	SITE ACCESS, CONDITIONS AND REQUIREMENTS	22
11.1.	Site Investigation	22
11.2.	Soils Investigation Report.....	22
11.3.	Access to Work	23
11.4.	Layout and Field Engineering.....	23
11.5.	Utilities	23
11.6.	Sanitary Facilities.....	23
11.7.	Surveys	23
11.8.	Regional Notification Center.....	23
11.9.	Existing Utility Lines.....	23
11.10.	Notification.....	24
11.11.	Hazardous Materials.....	24
11.12.	No Signs	24
12.	TRENCHES	24
12.1.	Trenches Greater Than Five Feet.....	24
12.2.	Excavation Safety	24
12.3.	No Tort Liability of District	25
12.4.	No Excavation without Permits.....	25
12.5.	Discovery of Hazardous Waste, Unusual Conditions and/or Unforeseen Conditions.....	25
13.	INSURANCE AND BONDS	25
13.1.	Insurance.....	25
13.2.	Contract Security – Bonds.....	28
14.	WARRANTY/GUARANTEE/INDEMNITY	28
14.1.	Warranty/Guarantee.....	28
14.2.	Indemnity.....	29
15.	TIME	30
15.1.	Notice to Proceed.....	30
15.2.	Hours of Work.....	30
15.3.	Progress and Completion.....	30

15.4.	Schedule	30
15.5.	Expeditious Completion.....	30
16.	EXTENSIONS OF TIME – LIQUIDATED DAMAGES	30
16.1.	Contractor’s Notice of Delay	31
16.2.	Excusable and Compensable Delay(s)	31
16.3.	Excusable Delay(s).....	32
16.4.	Unexcused Delay(s) – Liquidated Damages	33
17.	CHANGES IN THE WORK	33
17.1.	No Changes Without Authorization	33
17.2.	Architect Authority	34
17.3.	Change Orders.....	34
17.4.	Construction Change Directives / Unilateral Change Orders.....	34
17.5.	Force Account Directives	35
17.6.	Price Request	35
17.7.	Proposed Change Order	36
17.8.	Format for Proposed Change.....	36
17.9.	Change Order Certification	40
17.10.	Determination of Change Order Cost.....	40
17.11.	Deductive Change Orders.....	41
17.12.	Discounts, Rebates and Refunds	41
17.13.	Accounting Records.....	41
17.14.	Notice Required	41
17.15.	Applicability to Subcontractors.....	41
17.16.	Alteration to Change Order Language.....	41
17.17.	Failure of Contractor to Execute Change Order	41
18.	REQUEST FOR INFORMATION.....	41
19.	PAYMENTS	42
19.1.	Contract Price.....	42
19.2.	Applications for Progress Payments.....	42
19.3.	Progress Payments	44
19.4.	Decisions to Withhold Payment	46
19.5.	Subcontractor Payments.....	48
20.	COMPLETION OF THE WORK.....	48
20.1.	Completion.....	48
20.2.	Closeout Procedures.....	48
20.3.	Final Inspection	49

20.4.	Costs of Multiple Inspections	50
20.5.	Partial Occupancy or Use Prior to Completion	50
21.	FINAL PAYMENT AND RETENTION	51
21.1.	Final Payment	51
21.2.	Prerequisites for Final Payment.....	51
21.3.	Retention	51
21.4.	Substitution of Securities	52
22.	UNCOVERING OF WORK.....	52
23.	NONCONFORMING WORK AND CORRECTION OF WORK.....	52
23.1.	Nonconforming Work.....	52
23.2.	Correction of Work.....	52
23.3.	District's Right to Perform Work	53
24.	TERMINATION AND SUSPENSION.....	53
24.1.	District's Right to Terminate Contractor for Cause.....	53
24.2.	Emergency Termination of Public Contracts Act of 1949.....	55
24.3.	Termination of Contractor for Convenience	55
24.4.	Suspension of Work	56
24.5.	Scope Reduction	56
25.	DISPUTES AND CLAIMS.....	56
25.1.	Performance during Dispute and Claim Resolution Process.....	56
25.2.	Waiver.....	56
25.3.	Intention.....	56
25.4.	Exclusive Remedy.....	56
25.5.	Other Provisions.....	57
25.6.	Subcontractors.....	57
25.7.	Dispute and Claim Resolution Process.....	57
25.8.	Documentation of Resolution.....	61
25.9.	Dispute and Claim Resolution Process – Non-Applicability.....	61
26.	LABOR, WAGE & HOUR, APPRENTICE AND RELATED PROVISIONS.....	62
26.1.	Contractor & Subcontractor Registration	62
26.3.	Hours of Work.....	63
26.5.	Apprentices	65
26.6.	Non-Discrimination	66
26.7.	Labor First Aid.....	67
27.	MISCELLANEOUS.....	67
27.1.	Assignment of Antitrust Actions	67

27.2.	Excise Taxes.....	67
27.3.	Taxes.....	68
27.4.	Shipments.....	68
27.5.	Compliance with Government Reporting Requirements.....	68

GENERAL CONDITIONS

1. CONTRACT TERMS AND DEFINITIONS

1.1. Definitions

Wherever used in the Contract Documents, the following terms shall have the meanings indicated, which shall be applicable to both the singular and plural thereof:

1.1.1. Adverse Weather: Weather that satisfies all of the following conditions: (1) unusually severe precipitation, sleet, snow, hail, heat, or cold conditions in excess of the norm for the location and time of year it occurred, (2) unanticipated, and (3) occurring at the Project Site.

1.1.2. Allowance(s): Amount(s) stated in the Agreement for specific scopes of work for which Contractor may bill its time, materials, and other items in the identical structure as a Change Order.

1.1.3. Approval, Approved, and/or Accepted: Refer to written authorization, unless stated otherwise.

1.1.4. Architect: The individual, partnership, corporation, joint venture, or any combination thereof, named as Architect that has the rights and authority assigned to the Architect in the Contract Documents. The term Architect means the District's Architect on this Project or the Architect's authorized representative.

1.1.5. As-Built Drawings: A reproducible full-size sets of drawings to be prepared on a monthly basis, and upon Project Completion, pursuant to the Contract Documents, that reflect changes made during the performance of the Work, recording differences between the original design of the Work and the Work as constructed since the preceding monthly submittal.

1.1.6. Bidder: A contractor who intends to provide a bid to the District to perform the Work of the Contract.

1.1.7. Change Order: A written order to the Contractor authorizing an addition to, deletion from, or revision in the Work, and/or authorizing an adjustment in the Contract Price or Contract Time. If a Change Order is required to be approved by DSA, the District may call it a Construction Change Document.

1.1.8. Completion: When the entire Work shall have been completed to the satisfaction of District, including all punch list items. Final DSA approval of the Project is not required for Completion.

1.1.9. Construction Change Directive: A written order prepared and issued by the District, the Construction Manager, and/or the Architect and signed by the District and the Architect, directing a change in the Work. A Construction Change Directive is **NOT** a Construction Change Document (which is defined above as a Change Order that DSA must approve).

1.1.10. Construction Manager: The individual, partnership, corporation, joint venture, or any combination thereof, or its authorized representative, named as such by the District. If no Construction Manager is used on the Project, then all references in the Contract Documents to Construction Manager shall be read to refer to District.

1.1.11. Construction Schedule: The progress schedule of construction of the Project as provided by Contractor and approved by District.

1.1.12. Contract, Contract Documents: The Contract consists exclusively of the documents evidencing the agreement of the District and Contractor, identified as the Contract Documents. The Contract Documents consist of the following documents:

- 1.1.12.1. Invitation to Bid
- 1.1.12.2. Instructions to Bidders
- 1.1.12.3. Bid Form
- 1.1.12.4. Bid Bond (Security)
- 1.1.12.5. Designated Subcontractors List
- 1.1.12.6. Site-Visit Certification
- 1.1.12.7. Noncollusion Declaration
- 1.1.12.8. Iran Contracting Act Certification
- 1.1.12.9. Worker's Compensation Certification
- 1.1.12.10. Prevailing Wage and Related Labor Requirements Certification
- 1.1.12.11. Disabled Veteran's Business Enterprise Participation Certification
- 1.1.12.12. Drug-Free Workplace Certification
- 1.1.12.13. Tobacco-Free Environment Certification
- 1.1.12.14. Hazardous Materials Certification
- 1.1.12.15. Lead-Based Materials Certification
- 1.1.12.16. Imported Materials Certification
- 1.1.12.17. Criminal Background Investigation/Fingerprinting Certification
- 1.1.12.18. Roofing Contract Financial Interest Certification
- 1.1.12.19. Notice of Award
- 1.1.12.20. Agreement
- 1.1.12.21. Escrow of Bid Documentation (if applicable)
- 1.1.12.22. Escrow Agreement for Security Deposits in Lieu of Retention
- 1.1.12.23. Storm Water Pollution Prevention Plan (if applicable)
- 1.1.12.24. Hazardous Materials Procedures and Requirements
- 1.1.12.25. Notice to Proceed
- 1.1.12.26. Performance Bond
- 1.1.12.27. Payment Bond (Contractor's Labor and Material Bond)
- 1.1.12.28. District Contract Forms (if applicable)

- 1.1.12.29. District Closeout Forms (if applicable)
- 1.1.12.30. Final Settlement Agreement and Release of Claims
- 1.1.12.31. Warranty and Guarantee Form
- 1.1.12.32. General Conditions
- 1.1.12.33. Special Conditions
- 1.1.12.34. Project Plans, Specifications, Technical Specifications, and Drawings
- 1.1.12.35. Addenda to any of the above documents
- 1.1.12.36. Schedules if approved in writing by the District
- 1.1.12.37. Change Orders or written modifications to the above documents if approved in writing by the District

1.1.13. Contract Price: The total monies payable to the Contractor under the terms and conditions of the Contract Documents.

1.1.14. Contract Time: The time period stated in the Agreement for the Completion of the Work.

1.1.15. Contractor: The person or persons identified in the Agreement as contracting to perform the Work, or the legal representative of such person(s).

1.1.16. Daily Job Report(s): Daily Project reports prepared by the Contractor's employee(s) who are present on Site, which shall include the information required herein.

1.1.17. Day(s): Unless otherwise designated, day(s) means calendar day(s).

1.1.18. District: The public agency or the school district for which the Work is performed.

1.1.19. Drawings: (or "Plans") The graphic and pictorial portions of the Contract Documents showing the design, location, scope and dimensions of the Work, generally including plans, elevations, sections, details, schedules, sequence of operation, and diagrams.

1.1.20. DSA: Division of the State Architect.

1.1.21. Force Account Directive: A process that may be used when the District and the Contractor cannot agree on a price for a specific scope of work or before Contractor prepares a price for the scope of work, Contractor performs on a time and materials basis.

1.1.22. Premises: The real property owned by the District on which the Project Site is located.

1.1.23. Product(s): New material, machinery, components, equipment, fixtures and systems forming the Work, including existing materials or components required and approved by the District for reuse.

1.1.24. Product Data: Illustrations, standard schedules, performance charts, instructions, brochures, diagrams, and other information furnished by Contractor to illustrate a material, product, or system for a scope of the Work.

1.1.25. Project: The planned undertaking as provided for in the Contract Documents.

1.1.26. Project Inspector: (or "Inspector") Individual(s) retained by the District in accordance with title 24 of the California Code of Regulations to monitor and inspect the Project.

1.1.27. Program Manager: The individual, partnership, corporation, joint venture, or any combination thereof, or its authorized representative, named as such by the District. If no Program Manager is designated for the Project then all references to Project Manager shall refer to District.

1.1.28. Provide: Shall include "provide complete in place," that is, "furnish and install," and "provide complete and functioning as intended in place" unless specifically stated otherwise.

1.1.29. Request for Information: (or "RFI") A written request prepared by the Contractor requesting that the Architect provide additional information necessary to clarify or amplify an item in the Contract Documents that the Contractor believes is not clearly shown or called for in the Drawings or Specifications or other portions of the Contract Documents, or to address issues that have arisen under field conditions.

1.1.30. Request for Substitution: A request by Contractor to substitute an equal or superior material, product, thing, or service for a specific material, product, thing, or service that has been designated in the Contract Documents by a specific brand or trade name.

1.1.31. Safety Orders: Written and/or verbal orders for construction issued by the California Division of Industrial Safety ("CalOSHA") or by the United States Occupational Safety and Health Administration ("OSHA").

1.1.32. Safety Plan: Contractor's safety plan specifically adapted for the Project. Contractor's Safety Plan shall comply with all provisions regarding Project safety, including all applicable provisions in these General Conditions.

1.1.33. Samples: Physical examples that illustrate materials, products, equipment, finishes, colors, or workmanship and that, when approved in accordance with the Contract Documents, establish standards by which portions of the Work will be judged.

1.1.34. Shop Drawings: All drawings, prints, diagrams, illustrations, brochures, schedules, and other data that are prepared by the Contractor, a subcontractor, manufacturer, supplier, or distributor, that illustrate how specific portions of the Work shall be fabricated or installed.

1.1.35. Site: The Project site as shown on the Drawings.

1.1.36. Specifications: That portion of the Contract Documents, Division 1 through Division 17, and all technical sections, and addenda to all of these, if any, consisting of written descriptions and requirements of a technical nature of materials, equipment, construction methods and systems, standards, and workmanship.

1.1.37. Subcontractor: A contractor and/or supplier who is under contract with the Contractor or with any other subcontractor, regardless of tier, to perform a portion of the Work.

1.1.38. Submittal Schedule: The schedule of submittals as provided by Contractor and approved by District.

1.1.39. Surety: The person, firm, or corporation that executes as surety the Contractor's Performance Bond and Payment Bond, and must be a California admitted surety insurer as defined in the Code of Civil Procedure section 995.120.

1.1.40. SWPPP: The District's Storm Water Pollution Prevention Plan.

1.1.41. Work: All labor, materials, equipment, components, appliances, supervision, coordination, and services required by, or reasonably inferred from, the Contract Documents, that are necessary for the construction and Completion of the Project.

1.2. Laws Concerning the Contract

Contract is subject to all provisions of the Constitution and laws of California and the United States, governing, controlling, or affecting District, or the property, funds, operations, or powers of District, and such provisions are by this reference made a part hereof. Any provision required by law to be included in this Contract shall be deemed to be inserted.

1.3. No Oral Agreements

No oral agreement or conversation with any officer, agent, or employee of District, either before or after execution of Contract, shall affect or modify any of the terms or obligations contained in the Contract Documents.

1.4. No Assignment

Contractor shall not assign the Contract or any part thereof including, without limitation, any services or money to become due without the prior written consent of the District. Assignment without District's prior written consent shall be null and void. Any assignment of money due or to be come due under the Contract shall be subject to a prior lien for services rendered or material supplied for Work performed in favor of all persons, firms, or corporations rendering services or supplying material to the extent that claims are filed pursuant to the Civil Code, Code of Civil Procedure, Government Code, Labor Code, and/or Public Contract Code, and shall also be subject to deductions for Liquidated Damages or withholding of payments as determined by District in accordance with the Contract. Contractor shall not assign or transfer in any manner to a Subcontractor or supplier the right to prosecute or maintain an action against the District.

1.5. Notice And Service Thereof

1.5.1. Any notice required by the Contract shall be in writing, dated and signed by the party giving notice or by a duly authorized representative of that party. Notice shall be served and considered effective if given in one of the following manners:

1.5.1.1. By personal delivery; considered delivered on the day of delivery.

1.5.1.2. By overnight delivery service; considered delivered one (1) day after date deposited, as indicated by the delivery service.

1.5.1.3. By depositing same in United States mail, enclosed in a sealed envelope; considered delivered three (3) days after date deposited, as indicated by the postmarked date.

1.5.1.4. By registered or certified mail with postage prepaid, return receipt requested; considered delivered on the day the notice is signed for.

1.6. No Waiver

The failure of District in any one or more instances to insist upon strict performance of any term of the Contract or to exercise any District option shall not be construed as a waiver or relinquishment of the right to assert or rely upon any such term or option on a future occasion. No action or failure to act by the District, Architect, or Construction Manager shall constitute a waiver of any right or duty afforded the District under the Contract, nor shall any action or failure to act constitute an approval of or acquiescence in any breach hereunder, except as may be specifically agreed in writing.

1.7. Substitutions for Specified Items

See Special Conditions.

1.8. Materials and Work

1.8.1. Except as otherwise stated in the Contract, Contractor shall provide and pay for all materials, labor, tools, equipment, transportation, supervision, temporary constructions of every nature, and all other services, management, and facilities of every nature whatsoever necessary to execute and complete the Contract within the Contract Time.

1.8.2. Unless otherwise specified, all materials shall be new and the best of their respective kinds and grades as noted or specified, and workmanship shall be of good quality.

1.8.3. Materials shall be furnished in sufficient quantities and at such times as to insure uninterrupted progress of Work and shall be stored properly and protected as required.

1.8.4. For all materials and equipment specified or indicated in the Drawings, the Contractor shall provide all labor, materials, equipment, and services necessary for complete assemblies and complete working systems, functioning as intended. Incidental items not indicated on Drawings, nor mentioned in the Specifications, that can legitimately and reasonably be inferred to belong to the Work described, or be necessary in good practice to provide a complete assembly or system, shall be furnished as though itemized here in every detail. In all instances, material and equipment shall be installed in strict accordance with each manufacturer's most recent published recommendations and specifications.

1.8.5. Contractor shall, after award of Contract by District and after relevant submittals have been approved, place orders for materials and/or equipment as specified so that delivery of same may be made without delays to the Work. Contractor shall, upon demand from District, present documentary evidence showing that orders have been placed.

1.8.6. District reserves the right but has no obligation, for any neglect in complying with the above instructions, to place orders for such materials and/or equipment as it may deem advisable in order that the Work may be completed at the date specified in the Agreement, and all expenses incidental to the procuring of said materials and/or equipment shall be paid for by Contractor or withheld from payment(s) to Contractor.

1.8.7. Contractor warrants good title to all material, supplies, and equipment installed or incorporated in Work and agrees upon Completion of all Work to deliver the Site to District, together with all improvements and appurtenances constructed or placed thereon by it, and free from any claims, liens, or charges. Contractor further agrees that neither it nor any person, firm, or corporation furnishing any materials or labor for any Work shall have any right to lien any portion of the Premises or any improvement or appurtenance thereon, except that Contractor may install metering devices or other equipment of utility companies or of political subdivision, title to which is commonly retained by utility company or political subdivision. In the event of installation of any such metering device or equipment, Contractor shall advise District as to owner thereof.

1.8.8. Nothing contained in this Article, however, shall defeat or impair the rights of persons furnishing materials or labor under any bond given by Contractor for their protection or any rights under law permitting such protection or any rights under law permitting such persons to look to funds due Contractor in hands of District (e.g., stop payment notices). This provision shall be inserted in all subcontracts and material contracts and notice of its provisions shall be given to all persons furnishing material for work when no formal contract is entered into for such material.

1.8.9. Title to new materials and/or equipment for the Work and attendant liability for its protection and safety shall remain with Contractor until incorporated in the Work of this Contract and accepted by District. No part of any materials and/or equipment shall be removed from its place of storage except for immediate installation in the Work. Contractor shall keep an accurate inventory of all materials and/or equipment in a manner satisfactory to District or its authorized representative and shall, at the District's request, forward it to the District.

1.8.10. Contractor certifies that it shall comply with the recycled product requirements of Public Contract Code section 22150, et seq., including, without limitation, section 22154 which states, "All businesses shall

certify in writing to the contracting officer, or his or her representative, the minimum, if not exact, percentage of postconsumer material in the products, materials, goods, or supplies being offered or sold to any local public entity.”

2. DISTRICT

2.1.1. The governing board of the District or its designees will act for the District in all matters pertaining to the Contract.

2.1.2. The District may, at any time,

2.1.2.1. Direct the Contractor to communicate with or provide notice to the Construction Manager or the Architect on matters for which the Contract Documents indicate the Contractor will communicate with or provide notice to the District; and/or

2.1.2.2. Direct the Construction Manager or the Architect to communicate with or direct the Contractor on matters for which the Contract Documents indicate the District will communicate with or direct the Contractor.

2.1.3. **District's Rights if Contractor Fails to Perform.** If the District at any time believes that the Contractor is behind schedule, is failing to construct the Project pursuant to the Contract Documents or is otherwise failing to perform any provisions of this Contract, the District, after **FORTY-EIGHT (48)** hours written notice to the Contractor, may take any action necessary or beneficial to the District to complete the Project, take over the Work of the Contract, terminate or suspend the Contract as indicated herein, or any combination or portion of those actions. The Contractor and the Surety shall be liable to the District for any cost incurred by the District in those actions and the District has the right to deduct the cost thereof from any payment then or thereafter due the Contractor.

3. ARCHITECT

3.1. Architect shall have the authority to act on behalf of District to the extent expressly provided in the Contract Documents and to the extent determined by District to, among other things, observe the progress and quality of the Work on behalf of the District. Architect shall have authority to reject materials, workmanship, and/or the Work whenever rejection may be necessary, in Architect's reasonable opinion, to insure the proper execution of the Contract.

3.2. Architect shall, with the District and on behalf of the District, determine the amount, quality, acceptability, and fitness of all parts of the Work, and interpret the Specifications, Drawings, and shall, with the District, interpret all other Contract Documents.

3.3. Architect shall have all authority and responsibility established by law, including title 24 of the California Code of Regulations.

3.4. Contractor shall provide District and the Construction Manager with a copy of all written communication between Contractor and Architect at the same time as that communication is made to Architect, including, without limitation, all RFIs, correspondence, submittals, claims, and proposed change orders.

4. CONSTRUCTION MANAGER

4.1. If a Construction Manager is used on this Project, the Construction Manager will provide administration of the Contract on the District's behalf. After execution of the Contract and Notice to Proceed, all correspondence and/or instructions from Contractor and/or District shall be forwarded through the Construction Manager. The Construction Manager will not be responsible for and will not have control or charge of construction means, methods, techniques, sequences, or procedures or for safety precautions in connection with the Work, which shall all remain the Contractor's responsibility.

- 4.2. Construction Manager, however, will have authority to reject materials and/or workmanship not conforming to the Contract Documents, as determined by the District, the Architect, and/or the Project Inspector. Construction Manager shall also have the authority to require special inspection or testing of any portion of the Work, whether it has been fabricated, installed, or fully completed. Any decision made by Construction Manager, in good faith, shall not give rise to any duty or responsibility of the Construction Manager to the Contractor, any Subcontractor, their agents, employees, or other persons performing any of the Work. Construction Manager shall have free access to all parts of Work at any time.
- 4.3. If the District does not use a Construction Manager on this Project, all references to Construction Manager or CM shall be read as District.

5. INSPECTOR, INSPECTIONS AND TESTS

5.1. Project Inspector

5.1.1. One or more Project Inspector(s), including special Project Inspector(s), as required, will be assigned to the Work by District, in accordance with requirements of title 24, part 1, of the California Code of Regulations, to enforce the building code and monitor compliance with Plans and Specifications for the Project previously approved by the DSA. Duties of Project Inspector(s) are specifically defined in section 4-342 of said part 1 of title 24.

5.1.2. No Work shall be carried on except with the knowledge and under the inspection of the Project Inspector(s). The Project Inspector(s) shall have free access to all parts of Work at any time. Contractor shall furnish Project Inspector(s) reasonable opportunities for obtaining such information as may be necessary to keep Project Inspector(s) fully informed respecting progress and manner of work and character of materials. Inspection of Work shall not relieve Contractor from the obligation to fulfill the Contract. Project Inspector(s) and the DSA are authorized to stop work whenever the Contractor and/or its Subcontractor(s) are not complying with the Contract Documents. Any work stoppage by the Project Inspector(s) and/or DSA shall be without liability to the District. Contractor shall instruct its Subcontractors and employees accordingly.

5.1.3. If Contractor and/or any Subcontractor requests that the Project Inspector(s) perform any inspection off-site, this shall only be done if it is allowable pursuant to applicable regulations and DSA, if the Project Inspector(s) agree to do so, and at the expense of the Contractor.

5.2. Tests and Inspections

5.2.1. Tests and Inspections shall comply with title 24, part 1, California Code of Regulations, group 1, article 5, section 4-335, and with the provisions of the Specifications.

5.2.2. The District will select an independent testing laboratory to conduct the tests. Selection of the materials required to be tested shall be by the laboratory or the District's representative and not by the Contractor. The Contractor shall notify the District's representative a sufficient time in advance of its readiness for required observation or inspection.

5.2.3. The Contractor shall notify the District's representative a sufficient time in advance of the manufacture of material to be supplied under the Contract Documents, that must by terms of the Contract Documents be tested, in order that the District may arrange for the testing of same at the source of supply. This notice shall be, at a minimum, seventy-two (72) hours prior to the manufacture of the material that must be tested.

5.2.4. Any material shipped by the Contractor from the source of supply prior to having satisfactorily passed required testing and inspection or prior to the receipt of notice from the representative that testing and inspection will not be required, shall not be incorporated into and/or onto the Project.

5.2.5. The District will select and pay testing laboratory costs for all tests and inspections. Costs of tests of any materials found to be not in compliance with the Contract Documents shall be paid for by the District and reimbursed by the Contractor or deducted from the Contract Price.

5.3. Costs for After Hours and/or Off Site Inspections

5.3.1. If the Contractor performs Work outside the Inspector's regular working hours or requests the Inspector to perform inspections off Site, costs of any inspections required outside regular working hours or off Site shall be borne by the Contractor and may be invoiced to the Contractor by the District or the District may deduct those expenses from the next Progress Payment.

6. CONTRACTOR

Contractor shall construct the Work for the Contract price including any adjustment(s) to the Contract Price pursuant to provisions herein regarding changes to the Contract Price. Except as otherwise noted, Contractor shall provide and pay for all labor, materials, equipment, permits, fees, licenses, facilities, transportation, taxes, and services necessary for the proper execution and Completion of the Work, except as indicated herein.

6.1. Status of Contractor

6.1.1. Contractor is and shall at all times be deemed to be an independent contractor and shall be wholly responsible for the manner in which it and its Subcontractors perform the services required of it by the Contract Documents. Nothing herein contained shall be construed as creating the relationship of employer and employee, or principal and agent, between the District, or any of the District's employees or agents, and Contractor or any of Contractor's Subcontractors, agents or employees. Contractor assumes exclusively the responsibility for the acts of its employees as they relate to the services to be provided during the course and scope of their employment. Contractor, its Subcontractors, agents, and its employees shall not be entitled to any rights or privileges of District employees. District shall be permitted to monitor the Contractor's activities to determine compliance with the terms of the Contract.

6.1.2. As required by law, Contractor and all Subcontractors shall be properly licensed and regulated by the Contractor's State License Board, located at 9821 Business Park Drive, , Sacramento, California 95827, with a mailing address of Post Office Box 26000, Sacramento, California, and with a website at <http://www.cslb.ca.gov>.

6.2. Contractor's Supervision

6.2.1. During progress of the Work, Contractor shall keep on the Premises, and at all other locations where any Work related to the Contract is being performed, a competent project manager and construction superintendent who are employees of the Contractor, to whom the District does not object and at least one of whom shall be fluent in English, written and verbal.

6.2.2. The project manager and construction superintendent shall both speak fluently the predominant language of the Contractor's employees.

6.2.3. Before commencing the Work, Contractor shall give written notice to District of the name of its project manager and construction superintendent. Neither the Contractor's project manager nor construction superintendent shall be changed except with prior written notice to District, unless the Contractor's project manager and/or construction superintendent proves to be unsatisfactory to Contractor, District, any of the District's employees, agents, the Construction Manager, or the Architect, in which case, Contractor shall notify District in writing. District retains the right to reasonably refuse Contractor's replacement personnel. The Contractor's project manager and construction superintendent shall each represent Contractor, and all directions given to Contractor's project manager and/or construction superintendent shall be as binding as if given to Contractor.

6.2.4. Contractor shall give efficient supervision to Work, using its best skill and attention. Contractor shall carefully study and compare all Contract Documents, Drawings, Specifications, and other instructions and shall at once report to District, Construction Manager, and Architect any error, inconsistency, or omission that Contractor or its employees and Subcontractors may discover, in writing, with a copy to District's Project Inspector(s). The Contractor shall have responsibility for discovery of errors, inconsistencies, or omissions.

6.2.5. The Contractor's project manager shall devote sufficient time to the Project on site, and in the Contractor's home office to pre-plan activities to meet the Project schedule and fulfill all Contract obligations. This includes making timely submittals, issuing and disseminating necessary RFI's, promptly processing and distributing bulletins, change orders and payments, keeping required logs current etc. If any of these activities fall behind contract requirements or dates necessary to complete the Project on time, the Contractor must provide a full time project manager on the Project Site dedicated solely to the Project, until the deficiencies are corrected.

6.2.6. The Contractor shall verify all indicated dimensions before ordering materials or equipment, or before performing Work. The Contractor shall take field measurements, verify field conditions, and shall carefully compare such field measurements and conditions and other information known to the Contractor with the Project Documents before commencing work. Errors, inconsistencies or omissions discovered shall be immediately reported to the District. Upon commencement of any item of Work, the Contractor shall be responsible for dimensions related to the Work and shall make any corrections necessary to make Work properly fit at no additional cost to District. This responsibility for verification of dimensions is a non-delegable duty and may not be delegated to subcontractors or agents.

6.2.7. Omissions from the Drawings or Specifications, or the misdescription of details of Work which are manifestly necessary to carry out the intent of the Drawings and Specifications, or which are customarily performed, shall not relieve the Contractor from performing such omitted or misdescribed Work, but they shall be performed as if fully and correctly set forth and described in the Drawings and Specifications.

6.2.8. The Contractor shall be solely responsible for the means, methods, techniques, sequences, and procedures of construction. The Contractor shall be responsible to see that the finished Work complies accurately with the Contract Documents.

6.3. Duty to Provide Fit Workers

6.3.1. Contractor and Subcontractor(s) shall at all times enforce strict discipline and good order among their employees and shall not employ or work any unfit person or anyone not skilled in work assigned to that person. It shall be the responsibility of Contractor to ensure compliance with this requirement. District may require Contractor to permanently remove unfit persons from Project Site.

6.3.2. Any person in the employ of Contractor or Subcontractor(s) whom District may deem incompetent or unfit shall be excluded from working on the Project and shall not again be employed on the Project except with the prior written consent of District.

6.3.3. The Contractor shall furnish labor that can work in harmony with all other elements of labor employed or to be employed in the Work.

6.3.4. If Contractor intends to make any change in the name or legal nature of the Contractor's entity, Contractor must first notify the District. The District shall determine if Contractor's intended change is permissible while performing the Contract.

6.3.5. **Compliance with Immigration Reform and Control Act of 1986.** As required by law, Contractor and all Subcontractors shall employ individuals for the Work in conformity with the Immigration Reform and Control Act of 1986, 8 USC §§1101 et seq.

6.4. Personnel

6.4.1. All persons working for Contractor and Subcontractor(s) shall refrain from using profane or vulgar language, or any other language that is inappropriate on the job site.

6.4.2. The Contractor shall employ a full-time superintendent and necessary assistants who shall have complete authority to represent and act on behalf on the Contractor on all matters pertaining to the Work. The superintendent shall be competent and have a minimum of five (5) years experience in construction supervision on projects of similar scale and complexity. The superintendent shall be satisfactory to the District and, if not satisfactory, shall be replaced by the Contractor with one that is acceptable to the District. The superintendent shall not be changed without the written consent of the District unless the superintendent ceases to be employed by the Contractor.

6.4.3. The Contractor shall employ a competent estimator and necessary assistants, or contract for sufficient services of an estimating consultant and to process proposed change orders. The estimator shall have a minimum of five (5) years experience in estimating. The estimator shall be satisfactory to the District and, if not satisfactory, shall be replaced by the Contractor with one that is acceptable. The estimator shall not be changed without the written consent of the District unless the estimator ceases to be employed by the Contractor. The Contractor shall submit PCO's requested by the District within fourteen (14) calendar days.

6.4.4. The Contractor shall employ a competent scheduler and necessary assistants, or contract for sufficient services of a scheduling consultant. The scheduler shall have a minimum of five (5) years experience in scheduling. The scheduler shall be satisfactory to the District and, if not satisfactory, shall be replaced by the Contractor with one that is acceptable. The scheduler shall not be changed without the written consent of the District unless the scheduler ceases to be employed by the Contractor.

6.4.5. Contractor shall at all times enforce strict discipline and good order among Contractor's employees, and shall not employ on the Project any unfit person or anyone not skilled in the task assigned.

6.4.6. If Contractor or any Subcontractor on the Project site fails to comply with any provision herein, the District may have the offending person(s) immediately removed from the Site, and the person(s) shall be replaced within three (3) days, at no additional expense to the District. Contractor, on behalf of it and its Subcontractors, hereby waives any claim that the provisions of this paragraph or the enforcement thereof interferes, or has the potential to interfere, with its right to control the means and methods of its performance and duties under this Contract.

6.5. Purchase of Materials and Equipment

6.5.1. Error! Bookmark not defined.The Contractor is required to order and obtain materials and equipment sufficiently in advance of its Work at no additional cost or advance payment from District to assure that there will be no delays.

6.5.2. Off-Site Storage of Materials and Equipment. Contractor shall not store materials and/or equipment off site without first obtaining the District's express, written consent. If Contractor receives District's consent to store materials and/or equipment off site ("Stored Materials"), Contractor shall comply with all of the following:

6.5.2.1. Property of Others Insurance. Contractor shall procure and maintain, during the entire time Stored Materials are in off-site storage, insurance coverage acceptable to the District that shall protect Contractor and District from all claims for Stored Materials that are lost, stolen, or damaged. The District shall be named as a loss payee for this insurance coverage. The insurance coverage shall include a "loss payable endorsement" stating that all amounts payable will be paid as a joint-check to the Contractor and District. If approved in advance by District, this required insurance may be obtained by an "Employee Theft Protection Insurance Policy" or an "Employee Theft Protection Bond."

6.5.2.2. Payment for Stored Materials. District shall only make payment to Contractor for Stored Materials if agreed upon in advance, in writing, by the District and provided that Contractor submits an itemized list of all Stored Materials with Contractor's Application for Payment. Contractor's itemized list of all Stored Materials shall be supported by all of the following:

6.5.2.2.1. Itemized breakdown of the Stored Materials for the purpose of requesting partial payment, identifying the serial numbers and exact storage location of each piece of equipment and material; and

6.5.2.2.2. Verified invoices for the Stored Materials; and

6.5.2.2.3. Original copy of Property of Others Insurance, Employee Theft Protection Insurance Policy, or an Employee Theft Protection Bond based on the type of insurance required by the District. These documents shall include certificates and endorsements stating the coverage and that the District is a loss payee or obligee, as appropriate.

6.6. Documents on Work

6.6.1. Contractor shall at all times keep on the Work Site, or at another location as the District may authorize in writing, one legible copy of all Contract Documents, including Addenda and Change Orders, and titles 19 and 24 of the California Code of Regulations, the specified edition(s) of the Uniform Building Code (electronic versions are acceptable), all approved Drawings, Plans, Schedules, and Specifications, and all codes and documents referred to in the Specifications, and made part thereof. These documents shall be kept in good order and available to District, Construction Manager, Architect, Architect's representatives, the Project Inspector(s), and all authorities having jurisdiction. Contractor shall be acquainted with and comply with the provisions of these titles as they relate to this Project. (See particularly the duties of Contractor, title 24, part 1, California Code of Regulations, section 4-343.) Contractor shall also be acquainted with and comply with all California Code of Regulations provisions relating to conditions on this Project, particularly titles 8 and 17. Contractor shall coordinate with Architect and Construction Manager and shall submit its verified report(s) according to the requirements of title 24.

6.6.2. Daily Job Reports.

6.6.2.1. Contractor shall maintain, at a minimum, at least one (1) set of Daily Job Reports on the Project. These must be prepared by the Contractor's employee(s) who are present on Site, and must include, at a minimum, the following information:

6.6.2.1.1. A brief description of all Work performed on that day.

6.6.2.1.2. A summary of all other pertinent events and/or occurrences on that day.

6.6.2.1.3. The weather conditions on that day.

6.6.2.1.4. A list of all Subcontractor(s) working on that day,

6.6.2.1.5. A list of each Contractor employee working on that day and the total hours worked for each employee.

6.6.2.1.6. A complete list of all equipment on Site that day, whether in use or not.

6.6.2.1.7. A complete list of all materials, supplies, and equipment delivered on that day.

6.6.2.1.8. A complete list of all inspections and tests performed on that day.

6.6.2.2. Each day Contractor shall provide a copy of the previous day's Daily Job Report to the District or the District's Construction Manager.

6.7. Preservation of Records

District shall have the right to examine and audit all Daily Job Reports or other Project records of Contractor's project manager(s), project superintendent(s), and/or project foreperson(s), all certified payroll records and/or related documents including, without limitation, payroll, payment, timekeeping and tracking documents; all books, estimates, records, contracts, documents, bid documents, bid cost data, subcontract job cost reports, and other data of the Contractor, any Subcontractor, and/or supplier, including computations and projections related to bidding, negotiating, pricing, or performing the Work or Contract modification, in order to evaluate the accuracy, completeness, and currency of the cost, manpower, coordination, supervision, or pricing data at no additional cost to the District. These documents may be duplicative and/or be in addition to any Bid Documents held in escrow by the District. Contractor shall make available at its office at all reasonable times the materials described in this paragraph for the examination, audit, or reproduction until three (3) years after final payment under this Contract. Notwithstanding the provisions above, Contractor shall provide any records requested by any governmental agency, if available, after the time set forth above.

6.8. Integration of Work

6.8.1. Contractor shall do all cutting, fitting, patching, and preparation of Work as required to make its several parts come together properly, to fit it to receive or be received by work of other contractors, and to coordinate tolerances to various pieces of work, showing upon, or reasonably implied by, the Drawings and Specifications for the completed structure, and shall conform them as District and/or Architect may direct.

6.8.2. All cost caused by defective or ill-timed Work shall be borne by Contractor, inclusive of repair work.

6.8.3. Contractor shall not endanger any work performed by it or anyone else by cutting, excavating, or otherwise altering work and shall not cut or alter work of any other contractor except with written consent of District.

6.9. Obtaining of Permits and Licenses

6.9.1. Contractor shall secure and pay for all permits, licenses, and certificates as indicated in the Special Conditions.

6.10. Work to Comply with Applicable Laws and Regulations

6.10.1. Contractor shall give all notices and comply with all applicable laws, ordinances, rules, and regulations relating to the Work, including the specific laws, ordinances, rules, and regulations as indicated and specified in the Contract Documents and identified below, including but not limited to the appropriate statutes and administrative code sections. If Contractor observes that Drawings and Specifications are at variance therewith, or should Contractor become aware of the development of conditions not covered by Contract Documents that will result in finished Work being at variance therewith, Contractor shall promptly notify District in writing and any changes deemed necessary by District shall be made as provided in Contract for changes in Work.

6.10.1.1. National Electrical Safety Code, U. S. Department of Commerce

6.10.1.2. National Board of Fire Underwriters' Regulations

6.10.1.3. Uniform Building Code, latest addition, and the California Code of Regulations, title 24, including amendments

6.10.1.4. Manual of Accident Prevention in Construction, latest edition, published by A.G.C. of America

6.10.1.5. Industrial Accident Commission's Safety Orders, State of California

6.10.1.6. Regulations of the State Fire Marshall (title 19, California Code of Regulations) and Pertinent Local Fire Safety Codes

6.10.1.7. Americans with Disabilities Act

6.10.1.8. Education Code of the State of California

6.10.1.9. Government Code of the State of California

6.10.1.10. Labor Code of the State of California, division 2, part 7, Public Works and Public Agencies

6.10.1.11. Public Contract Code of the State of California

6.10.1.12. California Art Preservation Act

6.10.1.13. U. S. Copyright Act

6.10.1.14. U. S. Visual Artists Rights Act

6.10.2. Contractor shall comply will all applicable mitigation measures, if any, adopted by any public agency with respect to this Project pursuant to the California Environmental Quality Act (Public Resources Code sections 21000 et. seq.)

6.10.3. If Contractor performs any Work that it knew, or through exercise of reasonable care should have known, to be contrary to any applicable laws, ordinance, rules, or regulations, Contractor shall bear all costs arising therefrom.

6.10.4. Where Specifications or Drawings state that materials, processes, or procedures must be approved by the DSA, State Fire Marshall, or other body or agency, Contractor shall be responsible for satisfying requirements of such bodies or agencies.

6.11. Safety/Protection of Persons and Property

6.11.1. Contractor will be solely and completely responsible for conditions of the Work Site, including safety of all persons and property during performance of the Work. This requirement will apply continuously and not be limited to normal working hours.

6.11.2. The wearing of hard hats will be mandatory at all times for all personnel on Site. Contractor shall supply sufficient hard hats to properly equip all employees and visitors.

6.11.3. Any construction review of the Contractor's performance is not intended to include review of the adequacy of the Contractor's safety measures in, on, or near the Work Site.

6.11.4. Implementation and maintenance of safety programs shall be the sole responsibility of the Contractor.

6.11.5. Contractor shall furnish to the District a copy of the Contractor's safety plan within the time frame indicated in the Contract Documents and specifically adapted for the Project.

6.11.6. Contractor shall be responsible for all damages to persons or property that occur as a result of its fault or negligence in connection with the performance of the Contract and shall take all necessary measures and be responsible for the proper care and completion and final acceptance by District. All Work shall be solely at Contractor's risk with the exception of damage to the Work caused by "acts of God" as defined in Public Contract Code section 7105.

6.11.7. Contractor shall take, and require Subcontractors to take, all necessary precautions for safety of workers on the Project and shall comply with all applicable federal, state, local, and other safety laws, standards, orders, rules, regulations, and building codes to prevent accidents or injury to persons on, about, or adjacent to premises where Work is being performed and to provide a safe and healthful place of employment. Contractor shall furnish, erect, and properly maintain at all times, all necessary safety devices, safeguards, construction canopies, signs, nets, barriers, lights, and watchmen for protection of workers and the public and shall post danger signs warning against hazards created by such features in the course of construction.

6.11.8. **Hazards Control.** Contractor shall store volatile wastes in covered metal containers and remove them from the Site daily. Contractor shall prevent accumulation of wastes that create hazardous conditions. Contractor shall provide adequate ventilation during use of volatile or noxious substances.

6.11.9. Contractor shall designate a responsible member of its organization on the Project, whose duty shall be to post information regarding protection and obligations of workers and other notices required under occupational safety and health laws, to comply with reporting and other occupational safety requirements, and to protect the life, safety, and health of workers. Name and position of person so designated shall be reported to District by Contractor.

6.11.10. Contractor shall correct any violations of safety laws, rules, orders, standards, or regulations. Upon the issuance of a citation or notice of violation by the Division of Occupational Safety and Health, Contractor shall correct such violation promptly.

6.11.11. **Storm Water.** Contractor shall comply with the District's Storm Water Pollution Prevention Plan (SWPPP) and, if indicated in the Special Conditions, shall be the District's Qualified SWPPP Practitioner, at no additional cost to the District.

6.11.12. In an emergency affecting safety of life or of work or of adjoining property, Contractor, without special instruction or authorization, shall act, at its discretion, to prevent such threatened loss or injury. Any compensation claimed by Contractor on account of emergency work shall be determined by agreement.

6.11.13. All salvage materials will become the property of the Contractor and shall be removed from the Site unless otherwise called for in the Contract Documents. However, the District reserves the right to designate certain items of value that shall be turned over to the District unless otherwise directed by District.

6.11.14. All connections to public utilities and/or existing on-site services shall be made and maintained in such a manner as to not interfere with the continuing use of same by the District during the entire progress of the Work.

6.11.15. Contractor shall provide such heat, covering, and enclosures as are necessary to protect all Work, materials, equipment, appliances, and tools against damage by weather conditions, such as extreme heat, cold, rain, snow, dry winds, flooding, or dampness.

6.11.16. Contractor shall protect and preserve the Work from all damage or accident, providing temporary roofs, window and door coverings, boxing, or other construction as required by the Architect. Contractor shall be responsible for existing structures, walks, roads, trees, landscaping, and/or improvements in working areas; and shall provide adequate protection therefor. If temporary removal is necessary of any of the above items, or damage occurs due to the Work, the Contractor shall replace same at its expense with

same kind, quality, and size of Work or item damaged. This shall include any adjoining property of the District and others.

6.11.17. Contractor shall take adequate precautions to protect existing roads, sidewalks, curbs, pavements, utilities, adjoining property, and structures (including, without limitation, protection from settlement or loss of lateral support), and to avoid damage thereto, and repair any damage thereto caused by construction operations.

6.11.18. Contractor shall confine apparatus, the storage of materials, and the operations of workers to limits indicated by law, ordinances, permits, or directions of Architect, and shall not interfere with the Work or unreasonably encumber Premises or overload any structure with materials. Contractor shall enforce all instructions of District and Architect regarding signs, advertising, fires, and smoking, and require that all workers comply with all regulations while on Project Site.

6.11.19. Contractor, Contractor's employees, Subcontractors, Subcontractors' employees, or any person associated with the Work shall conduct themselves in a manner appropriate for a school site. No verbal or physical contact with neighbors, students, and faculty, profanity, or inappropriate attire or behavior will be permitted. District may require Contractor to permanently remove noncomplying persons from Project Site.

6.11.20. Contractor shall take care to prevent disturbing or covering any survey markers, monuments, or other devices marking property boundaries or corners. If such markers are disturbed, Contractor shall have a civil engineer, registered as a professional engineer in California, replace them at no cost to District.

6.11.21. In the event that the Contractor enters into any agreement with owners of any adjacent property to enter upon the adjacent property for the purpose of performing the Work, Contractor shall fully indemnify, defend, and hold harmless each person, entity, firm, or agency that owns or has any interest in adjacent property. The form and content of the agreement of indemnification shall be approved by the District prior to entering the adjacent property. The Contractor shall also indemnify the District as provided in the indemnification provision herein. These provisions shall be in addition to any other requirements of the owners of the adjacent property.

6.12. Working Evenings and Weekends

Contractor may be required to work evenings and/or weekends at no additional cost to the District. Contractor shall give the District seventy-two (72) hours notice prior to performing any evening and/or weekend work. Contractor shall perform all evening and/or weekend work only upon District's written approval and in compliance with all applicable rules, regulations, laws, and local ordinances including, without limitation, all noise and light limitations. Contractor shall reimburse the District for any Inspector charges necessitated by the Contractor's evening and/or weekend work.

6.13. Cleaning Up

6.13.1. The Contractor shall provide all services, labor, materials, and equipment necessary for protecting the Work, all school occupants, furnishings, equipment, and building structure from damage until its Completion and final acceptance by District. Dust barriers shall be provided to isolate dust and dirt from construction operations. At Completion of the Work and portions thereof, Contractor shall clean to the original state any areas beyond the Work area that become dust laden as a result of the Work. The Contractor must erect the necessary warning signs and barricades to ensure the safety of all school occupants. The Contractor at all times must maintain good housekeeping practices to reduce the risk of fire damage and must make a fire extinguisher, fire blanket, and/or fire watch, as applicable, available at each location where cutting, braising, soldering, and/or welding is being performed or where there is an increased risk of fire.

6.13.2. Contractor at all times shall keep Premises free from debris such as waste, rubbish, and excess materials and equipment caused by the Work. Contractor shall not leave debris under, in, or about the

Premises, but shall promptly remove same from the Premises on a daily basis. If Contractor fails to clean up, District may do so and the cost thereof shall be charged to Contractor. If Contract is for work on an existing facility, Contractor shall also perform specific clean-up on or about the Premises upon request by the District as it deems necessary for the continuing education process. Contractor shall comply with all related provisions of the Specifications.

6.13.3. If the Construction Manager, Architect, or District observes the accumulation of trash and debris, the District will give the Contractor a 24-hour written notice to mitigate the condition.

6.13.4. Should the Contractor fail to perform the required clean-up, or should the clean-up be deemed unsatisfactory by the District, the District will then perform the clean-up. All cost associated with the clean-up work (including all travel, payroll burden, and costs for supervision) will be deducted from the Contract Price, or District may withhold those amounts from payment(s) to Contractor.

7. SUBCONTRACTORS

7.1. Contractor shall provide the District with information for all Subcontracts as required in the Contractor's Submittals and Schedules Section.

7.2. No contractual relationship exists between the District and any Subcontractor, supplier, or sub-subcontractor by reason of the Contract.

7.3. Contractor agrees to bind every Subcontractor by terms of the Contract as far as those terms are applicable to Subcontractor's work. If Contractor shall subcontract any part of the Contract, Contractor shall be as fully responsible to District for acts and omissions of any Subcontractor and of persons either directly or indirectly employed by any Subcontractor, as it is for acts and omissions of persons directly employed by Contractor. The divisions or sections of the Specifications are not intended to control the Contractor in dividing the Work among Subcontractors or limit the work performed by any trade.

7.4. District's consent to, or approval of, or failure to object to, any Subcontractor under the Contract shall not in any way relieve Contractor of any obligations under the Contract and no such consent shall be deemed to waive any provisions of the Contract.

7.5. Contractor is directed to familiarize itself with sections 4100 through 4114 of the Public Contract Code of the State of California, as regards subletting and subcontracting, and to comply with all applicable requirements therein. In addition, Contractor is directed to familiarize itself with sections 1720 through 1861 of the Labor Code of the State of California, as regards the payment of prevailing wages and related issues, and to comply with all applicable requirements therein all including, without limitation, section 1775 and the Contractor's and Subcontractors' obligations and liability for violations of prevailing wage law and other applicable laws.

7.6. No Contractor whose Bid is accepted shall, without consent of the awarding authority and in full compliance with section 4100, et seq, of the Public Contract Code, including, without limitation, sections 4107, 4107.5, and 4109 of the Public Contract Code, either:

7.6.1. Substitute any person as a Subcontractor in place of the Subcontractor designated in the original Bid; or

7.6.2. Permit any Subcontract to be assigned or transferred, or allow any portion of the Work to be performed by anyone other than the original Subcontractor listed in the Bid; or

7.6.3. Sublet or subcontract any portion of the Work in excess of one-half of one percent (1/2 of 1%) of the Contractor's total bid as to which his original bid did not designate a Subcontractor.

- 7.7. The Contractor shall be responsible for the coordination of the trades, Subcontractors, sub-subcontractors, and material or equipment suppliers working on the Project.
- 7.8. Contractor is solely responsible for settling any differences between the Contractor and its Subcontractor(s) or between Subcontractors.
- 7.9. Contractor must include in all of its subcontracts the assignment provisions as indicated in the Termination section of these General Conditions.

8. OTHER CONTRACTS/CONTRACTORS

- 8.1. District reserves the right to let other contracts, and/or to perform work with its own forces, in connection with the Project. Contractor shall afford other contractors reasonable opportunity for introduction and storage of their materials and execution of their work and shall properly coordinate and connect Contractor's Work with the work of other contractors.
- 8.2. In addition to Contractor's obligation to protect its own Work, Contractor shall protect the work of any other contractor that Contractor encounters while working on the Project.
- 8.3. If any part of Contractor's Work depends for proper execution or results upon work of District or any other contractor, Contractor shall inspect and promptly report to the District in writing before proceeding with its Work any defects in District's or any other contractor's work that render Contractor's Work unsuitable for proper execution and results. Contractor shall be held accountable for damages to District for District's or any other contractor's work that Contractor failed to inspect or should have inspected. Contractor's failure to inspect and report shall constitute Contractor's acceptance of all District's or any other contractor's work as fit and proper for reception of Contractor's Work, except as to defects that may develop in District's or any other contractor's work after execution of Contractor's Work.
- 8.4. To ensure proper execution of its subsequent work, Contractor shall measure and inspect work already in place and shall at once report to the District in writing any discrepancy between that executed work and the Contract Documents.
- 8.5. Contractor shall ascertain to its own satisfaction the scope of the Project and nature of District's or any other contracts that have been or may be awarded by District in completion of the Project to the end that Contractor may perform this Contract in light of the other contracts, if any.
- 8.6. Nothing herein contained shall be interpreted as granting to Contractor exclusive occupancy of the Site, the Premises, or of the Project. The District shall have complete access to the Project site for any reasonable purpose at all times. Contractor shall not cause any unnecessary hindrance or delay to the use and/or school operation(s) of the Premises and/or to District or any other contractor working on the Project. If simultaneous execution of any contract or school operation is likely to cause interference with performance of Contractor's Contract, Contractor shall coordinate with those contractor(s), person(s), and/or entity(s) and shall notify the District of the resolution.

9. DRAWINGS AND SPECIFICATIONS

- 9.1. A complete list of all Drawings that form a part of the Contract is to be found as an index on the Drawings themselves, and/or may be provided to the Contractor and/or in the Table of Contents.
- 9.2. Materials or Work described in words that so applied have a well known technical or trade meaning shall be deemed to refer to recognized standards, unless noted otherwise.
- 9.3. Trade Name or Trade Term. It is not the intention of the Contract to go into detailed descriptions of any materials and/or methods commonly known to the trade under "trade name" or "trade term." The mere mention or notation of "trade name" or "trade term" shall be considered sufficient notice to Contractor

that it will be required to complete the work so named, complete, finished, and operable, with all its appurtenances, according to the best practices of the trade.

- 9.4. The naming of any material and/or equipment shall mean furnishing and installing of same, including all incidental and accessory items thereto and/or labor therefor, as per best practices of the trade(s) involved, unless specifically noted otherwise.
- 9.5. Contract Documents are complementary, and what is called for by one shall be binding as if called for by all. As such, Drawings and Specifications are intended to be fully cooperative and to agree. However, if Contractor observes that Drawings and Specifications are in conflict, Contractor shall promptly notify District and Architect in writing, and any necessary changes shall be made as provided in the Contract Documents.
- 9.6. In the case of discrepancy or ambiguity in the Contract Documents, the order of precedence in the Agreement shall prevail. However, in the case of discrepancy or ambiguity solely between and among the Drawings and Specifications, the discrepancy or ambiguity shall be resolved in favor of the interpretation that will provide District with the functionally complete and operable Project described in the Drawings and Specifications. In case of ambiguity, conflict, or lack of information, District will furnish clarifications with reasonable promptness.
- 9.7. Drawings and Specifications are intended to comply with all laws, ordinances, rules, and regulations of constituted authorities having jurisdiction, and where referred to in the Contract Documents, the laws, ordinances, rules, and regulations shall be considered as a part of the Contract within the limits specified. Contractor shall bear all expense of correcting work done contrary to said laws, ordinances, rules, and regulations.

9.8. Ownership of Drawings

9.8.1. All copies of the Drawings, Designs, Specifications, and copies of other incidental architectural and engineering work, or copies of other Contract Documents furnished by District, are the property of District. They are not to be used by Contractor in other work and, with the exception of signed sets of Contract Documents, are to be returned to District on request at Completion of Work, or may be used by District as it may require without any additional costs to District. Neither the Contractor nor any Subcontractor, or material or equipment supplier shall own or claim a copyright in the Drawings, Specifications, and other documents prepared by the Architect. District hereby grants the Contractor, Subcontractors, sub-subcontractors, and material or equipment suppliers a limited license to use applicable portions of the Drawings prepared for the Project in the execution of their Work under the Contract Documents.

10. CONTRACTOR'S SUBMITTALS AND SCHEDULES

Contractor's submittals shall comply with the provisions and requirements of the Specifications including, without limitation Submittals.

10.1. Schedules, Safety Plan and Complete Subcontractor List

10.1.1. Within **TEN (10)** calendar days after the date of the Notice to Proceed (unless otherwise specified in the Notice to Proceed or in the Special Conditions), Contractor shall prepare and submit to the District for review, in a form supported by sufficient data to substantiate its accuracy as the District may require:

10.1.1.1. Schedule of Work. Contractor shall provide a preliminary schedule of construction indicating the starting and completion dates of the various stages of the Work, including any information and following any form as may be specified in the Specifications. Once approved by District, this shall become the Construction Schedule. This schedule shall include and identify all tasks that are on the Project's critical path with a specific determination of the start and completion of

each critical path task, all contract milestones and each milestone's completion date(s) as may be required by the District, and the date of Project Completion.

10.1.1.1.1. Proposed Advanced Schedule. The District is not required to accept an early completion ("advanced") schedule; i.e., one that shows early completion dates for the Contract completion or milestones. Contractor shall not be entitled to extra compensation if the District allows the Contractor to proceed performing the Contract on an earlier ("advanced") schedule and Contractor completes the Project, for whatever reason, beyond the date shown in that earlier ("advanced") schedule, but within the Time for Completion indicated in the Contract. A schedule showing the work completed in less than the Time for Completion indicated in the Contract, shall be considered to have Project Float.

10.1.1.1.2. Float or Slack in the Schedule. Float or slack is the amount of time between the early start date and the late start date, or the early finish date and the late finish date, of any of the activities in the schedule. Float or slack is not for the exclusive use of or benefit of either the District or the Contractor, but its use shall be determined solely by the District.

10.1.1.2. Schedule of Submittals. The Contractor shall provide a preliminary schedule of submittals, including Shop Drawings, Product Data, and Samples submittals. Once approved by District, this shall become the Submittal Schedule. All submittals shall be forwarded to the District by the date indicated on the approved Submittal Schedule, unless an earlier date is necessary to maintain the Construction Schedule, in which case those submittals shall be forwarded to the District so as not to delay the Construction Schedule.

10.1.1.3. Schedule of Values. The Contractor shall provide a preliminary schedule of values for all component parts of the Work for which progress payments may be requested. The schedule of values must include quantities and prices of items totaling the Contract Price and must subdivide the Work into component parts in sufficient detail to serve as the basis for progress payments during construction. The preliminary schedule of values should include, at a minimum, the following information and the following structure:

10.1.1.3.1. Divided into at least the following categories:

- 10.1.1.3.1.1. Overhead and profit;
- 10.1.1.3.1.2. Supervision;
- 10.1.1.3.1.3. General conditions;
- 10.1.1.3.1.4. Layout;
- 10.1.1.3.1.5. Mobilization;
- 10.1.1.3.1.6. Submittals;
- 10.1.1.3.1.7. Bonds and insurance;
- 10.1.1.3.1.8. Closeout documentation;
- 10.1.1.3.1.9. Demolition;
- 10.1.1.3.1.10. Installation;
- 10.1.1.3.1.11. Rough-in;
- 10.1.1.3.1.12. Finishes;
- 10.1.1.3.1.13. Testing;
- 10.1.1.3.1.14. Punchlist and acceptance.

10.1.1.3.2. Divided by each of the following areas:

- 10.1.1.3.2.1. Site work;
- 10.1.1.3.2.2. By each building;
- 10.1.1.3.2.3. By each floor.

10.1.1.3.3. The preliminary schedule of values shall not provide for values any greater than the following percentages of the Contract value:

- 10.1.1.3.3.1. Mobilization and layout combined to equal not more than 1%;
- 10.1.1.3.3.2. Submittals, samples and shop drawings combined to equal not more than 3%;
- 10.1.1.3.3.3. Bonds and insurance combined to equal not more than 2%.

10.1.1.3.4. Closeout Documentation. Closeout Documentation shall have a value in the preliminary schedule of not less than 5%. The value for Closeout Documentation shall be in addition to and shall not be a part of the Contract retention.

10.1.1.3.5. Notwithstanding any provision of the Contract Documents to the contrary, payment of the Contractor's overhead, supervision, general conditions costs, and profit, as reflected in the Cost Breakdown, shall be paid by the District in equal installments, based on percentage complete, with the disbursement of Progress Payments and the Final Payment.

10.1.1.3.6. Contractor shall certify that the preliminary schedule of values as submitted to the District is accurate and reflects the costs as developed in preparing Contractor's bid. The preliminary schedule of values shall be subject to the District's review and approval of the form and content thereof. In the event that the District objects to any portion of the preliminary schedule of values, the District shall notify the Contractor, in writing, of the District's objection(s) to the preliminary schedule of values. Within five (5) calendar days of the date of the District's written objection(s), Contractor shall submit a revised preliminary schedule of values to the District for review and approval. The foregoing procedure for the preparation, review and approval of the preliminary schedule of values shall continue until the District has approved the entirety of the preliminary schedule of values.

10.1.1.3.7. Once the preliminary schedule of values is approved by the District, this shall become the Schedule of Values. The Schedule of Values shall not be thereafter modified or amended by the Contractor without the prior written consent and approval of the District, which may be granted or withheld in the sole discretion of the District.

10.1.1.4. Safety Plan. The Contractor shall provide a preliminary Contractor's Safety Plan specifically adapted for the Project. Contractor's Safety Plan shall comply with the following requirements:

10.1.1.4.1. All applicable requirements of California Division of Industrial Safety ("CalOSHA") and/or of the United States Occupational Safety and Health Administration ("OSHA").

10.1.1.4.2. All provisions regarding Project safety, including all applicable provisions in these General Conditions.

10.1.1.4.3. Contractor's Safety Plan shall be prepared in both English and in the predominate language(s) of the Contractor's and its Subcontractors' employees.

10.1.1.5. Complete Subcontractor List. Contractor shall provide a preliminary Subcontractor List stating the name, address, telephone number, facsimile number, California State Contractors License number, classification, and monetary value of all Subcontracts for parties furnishing labor, material, or equipment for the Project.

10.1.2. Contractor must provide all schedules both in hard copy and electronically, in a format (e.g., Microsoft Project or Primavera) approved in advance by the District.

10.1.3. The District will review the schedules submitted and the Contractor shall make changes and corrections in the schedules as requested by the District and resubmit the schedules until approved by the District.

10.1.4. The District shall have the right at any time to revise the Schedule of Values if, in the District's sole opinion, the Schedule of Values does not accurately reflect the value of the Work performed.

10.1.5. All submittals and schedules must be approved by the District before Contractor can rely on them as a basis for payment.

10.2. Monthly Progress Schedule(s)

10.2.1. Contractor shall provide Monthly Progress Schedule(s) to the District. A Monthly Progress Schedule shall update the approved Construction Schedule or the last Monthly Progress Schedule, showing all work completed and to be completed. The Monthly Progress Schedule shall be sent to the District and shall be in a format acceptable to the District and contain a written narrative of the progress of work that month and any changes, delays, or events that may affect the work. The process for District approval of the Monthly Progress Schedule shall be the same as the process for approval of the Construction Schedule.

10.2.2. Contractor shall also submit Monthly Progress Schedule(s) with all payment applications.

10.3. Material Safety Data Sheets (MSDS)

Contractor is required to ensure Material Safety Data Sheets are available in a readily accessible place at the Work Site for any material requiring a Material Safety Data Sheet per the Federal "Hazard Communication" standard, or employees right to know law. The Contractor is also required to ensure proper labeling on substances brought onto the Project Site and that any person working with the material or within the general area of the material is informed of the hazards of the substance and follows proper handling and protection procedures. Two additional copies of the Material Safety Data Sheets shall also be submitted directly to the District.

10.4. Logistic Plan

Contractor shall provide a staging and logistics plan identifying laydown areas, loading and unloading areas, crane locations, fence locations, temporary utility connections, trailer locations, and emergency evacuation meeting area. This Logistics Plan must be approved by the District prior to the Contractor mobilizing on the Site.

11. SITE ACCESS, CONDITIONS AND REQUIREMENTS

11.1. Site Investigation

Before bidding on the Work, Contractor shall make a careful investigation of the Site and thoroughly familiarize itself with the requirements of the Contract. By the act of submitting a bid for the Work included in the Contract, Contractor shall be deemed to have made a complete study and investigation, and to be familiar with and accepted the existing conditions of the Site.

11.2. Soils Investigation Report

11.2.1. When a soils investigation report obtained from test holes at Site is available, that report shall be available to the Contractor but shall not be a part of the Contract. Any information obtained from that report or any information given on Drawings as to subsurface soil condition or to elevations of existing grades or elevations of underlying rock is approximate only, is not guaranteed, does not form a part of the Contract, and Contractor may not rely thereon. By submitting its bid, Contractor acknowledges that it made visual examination of Site and made whatever tests Contractor deems appropriate to determine underground condition of soil.

11.2.2. Contractor agrees that no claim against District will be made by Contractor for damages and hereby waives any rights to damages if, during progress of Work, Contractor encounters subsurface or latent conditions at Site materially differing from those shown on Drawings or indicated in Specifications, or for unknown conditions of an unusual nature that differ materially from those ordinarily encountered in the work of the character provided for in Plans and Specifications, except as indicated in the provisions of these General Conditions regarding trenches, trenching, and/or existing utility lines.

11.3. Access to Work

District and its representatives shall at all times have access to Work wherever it is in preparation or progress, including storage and fabrication. Contractor shall provide safe and proper facilities for access so that District's representatives may perform their functions.

11.4. Layout and Field Engineering

11.4.1. All field engineering required for layout of this Work and establishing grades for earthwork operations shall be furnished by Contractor at its expense. This Work shall be done by a qualified, California-registered civil engineer approved in writing by District and Architect. Any required Record and/or As-Built Drawings of Site development shall be prepared by the approved civil engineer.

11.4.2. Contractor shall be responsible for having ascertained pertinent local conditions such as location, accessibility, and general character of the Site and for having satisfied itself as to the conditions under which the Work is to be performed. District shall not be liable for any claim for allowances because of Contractor's error or negligence in acquainting itself with the conditions at the Site.

11.4.3. Contractor shall protect and preserve established benchmarks and monuments and shall make no changes in locations without the prior written approval of District. Contractor shall replace any benchmarks or monuments that are lost or destroyed subsequent to proper notification of District and with District's approval.

11.5. Utilities

Utilities shall be provided as indicated in the Specifications.

11.6. Sanitary Facilities

Sanitary facilities shall be provided as indicated in the Specifications.

11.7. Surveys

Contractor shall provide surveys done by a California-licensed civil engineer surveyor to determine locations of construction, grading, and site work as required to perform the Work.

11.8. Regional Notification Center

Contractor, except in an emergency, shall contact the appropriate regional notification center at least two (2) days prior to commencing any excavation if the excavation will be conducted in an area or in a private easement that is known, or reasonably should be known, to contain subsurface installations other than the underground facilities owned or operated by the District, and obtain an inquiry identification number from that notification center. No excavation shall be commenced and/or carried out by the Contractor unless an inquiry identification number has been assigned to the Contractor or any Subcontractor and the Contractor has given the District the identification number. Any damages arising from Contractor's failure to make appropriate notification shall be at the sole risk and expense of the Contractor. Any delays caused by failure to make appropriate notification shall be at the sole risk of the Contractor and shall not be considered for an extension of the Contract time.

11.9. Existing Utility Lines

11.9.1. Pursuant to Government Code section 4215, District assumes the responsibility for removal, relocation, and protection of main or trunk utility lines and facilities located on the construction Site at the time of commencement of construction under the Contract with respect to any such utility facilities that are not identified in the Plans and Specifications. Contractor shall not be assessed for liquidated damages for

delay in completion of the Project caused by failure of District or the owner of a utility to provide for removal or relocation of such utility facilities.

11.9.2. Locations of existing utilities provided by District shall not be considered exact, but approximate within reasonable margin and shall not relieve Contractor of responsibilities to exercise reasonable care nor costs of repair due to Contractor's failure to do so. District shall compensate Contractor for the costs of locating, repairing damage not due to the failure of Contractor to exercise reasonable care, and removing or relocating such utility facilities not indicated in the Plans and Specifications with reasonable accuracy, and for equipment necessarily idle during such work.

11.9.3. No provision herein shall be construed to preclude assessment against Contractor for any other delays in completion of the Work. Nothing in this Article shall be deemed to require District to indicate the presence of existing service laterals, appurtenances, or other utility lines, within the exception of main or trunk utility lines. Whenever the presence of these utilities on the Site can be inferred from the presence of other visible facilities, such as buildings, meter junction boxes, on or adjacent to the Site.

11.9.4. If Contractor, while performing Work, discovers utility facilities not identified by District in Contract Plans and Specifications, Contractor shall immediately, but in no case longer than two (2) business days, notify the District and the utility in writing. The cost of repair for damage to above-mentioned visible facilities without prior written notification to the District shall be borne by the Contractor.

11.10. Notification

Contractor understands, acknowledges and agrees that the purpose for prompt notification to the District pursuant to these provisions is to allow the District to investigate the condition(s) so that the District shall have the opportunity to decide how the District desires to proceed as a result of the condition(s). Accordingly, failure of Contractor to promptly notify the District in writing, pursuant to the applicable provisions of these General Conditions, shall constitute Contractor's waiver of any claim for damages or delay incurred as a result of the condition(s).

11.11. Hazardous Materials

Contractor shall comply with all provisions and requirements of the Contract Documents related to hazardous materials including, without limitation, Hazardous Materials Procedures and Requirements.

11.12. No Signs

Neither the Contractor nor any other person or entity shall display any signs not required by law or the Contract Documents at the Site, fences trailers, offices, or elsewhere on the Site without specific prior written approval of the District.

12. TRENCHES

12.1. Trenches Greater Than Five Feet

Pursuant to Labor Code section 6705, if the Contract Price exceeds \$25,000 and involves the excavation of any trench or trenches five (5) feet or more in depth, the Contractor shall, in advance of excavation, promptly submit to the District and/or a registered civil or structural engineer employed by the District or Architect, a detailed plan showing the design of shoring for protection from the hazard of caving ground during the excavation of such trench or trenches.

12.2. Excavation Safety

If such plan varies from the Shoring System Standards established by the Construction Safety Orders, the plan shall be prepared by a registered civil or structural engineer, but in no case shall such plan be less

effective than that required by the Construction Safety Orders. No excavation of such trench or trenches shall be commenced until said plan has been accepted by the District or by the person to whom authority to accept has been delegated by the District.

12.3. No Tort Liability of District

Pursuant to Labor Code section 6705, nothing in this Article shall impose tort liability upon the District or any of its employees.

12.4. No Excavation without Permits

The Contractor shall not commence any excavation Work until it has secured all necessary permits including the required CAL OSHA excavation/shoring permit. Any permits shall be prominently displayed on the Site prior to the commencement of any excavation.

12.5. Discovery of Hazardous Waste, Unusual Conditions and/or Unforeseen Conditions

12.5.1. Pursuant to Public Contract Code section 7104, if the Work involves digging trenches or other excavations that extend deeper than four (4) feet below the surface, the Contractor shall immediately, but in no case longer than two (2) business days, and before the following conditions are disturbed, notify the District, in writing, of any:

12.5.1.1. Material that the Contractor believes may be material that is hazardous waste, as defined in section 25117 of the Health and Safety Code, and requires removal to a Class I, Class II, or Class III disposal site in accordance with provisions of existing law.

12.5.1.2. Subsurface or latent physical conditions at the Site differing from those indicated.

12.5.1.3. Unknown physical conditions at the Site of any unusual nature, different materially from those ordinarily encountered and generally recognized as inherent in work of the character provided for in the Contract.

12.5.2. The District shall promptly investigate the conditions, and if it finds that the conditions do materially so differ, or do involve hazardous waste, and cause a decrease or increase in the Contractor's cost of, or the time required for, performance of any part of the Work, shall issue a Change Order under the procedures described herein.

12.5.3. In the event that a dispute arises between District and the Contractor whether the conditions materially differ, or involve hazardous waste, or cause a decrease or increase in the Contractor's cost of, or time required for, performance of any part of the Work, the Contractor shall not be excused from any scheduled Completion date provided for by the Contract, but shall proceed with all work to be performed under the Contract. The Contractor shall retain any and all rights provided by the Contract or by law that pertain to the resolution of disputes and protests, which include the requirement that Contractor complies with the notice and PCO provisions of the Contract Documents. Contractor's failure to submit a proposed change order pursuant to the terms of the Contract Documents shall be deemed a waiver of Contractor's right to an adjustment of the Contract Price of Contract Time.

13. INSURANCE AND BONDS

13.1. Insurance

Unless different provisions and/or limits are indicated in the Special Conditions, all insurance required of Contractor and/or its Subcontractor(s) shall be in the amounts and include the provisions set forth herein.

13.1.1. Commercial General Liability and Automobile Liability Insurance

13.1.1.1. Contractor shall procure and maintain, during the life of the Contract, Commercial General Liability Insurance and Automobile Liability Insurance that shall protect Contractor, District, State, Construction Manager(s), Project Inspector(s), and Architect(s) from all claims for bodily injury, property damage, personal injury, death, advertising injury, and medical payments arising from operations under the Contract. This coverage shall be provided in a form at least as broad as the Insurance Services Office (ISO) standard form. Contractor shall ensure that Products Liability and Completed Operations coverage, Fire Damage Liability, and any Auto including owned, non-owned, and hired, are included within the above policies and at the required limits, or Contractor shall procure and maintain these coverages separately.

13.1.1.2. Contractor's deductible or self-insured retention for its Commercial General Liability Insurance policy shall not exceed \$25,000 unless approved in writing by District.

13.1.2. Umbrella Liability Insurance

13.1.2.1. Contractor may procure and maintain, during the life of the Contract, an Umbrella Liability Insurance Policy to meet the policy limit requirements of the required policies if Contractor's underlying policy limits are less than required.

13.1.2.2. There shall be no gap between the per occurrence amount of any underlying policy and the start of the coverage under the Umbrella Liability Insurance Policy. Any Umbrella Liability Insurance Policy shall protect Contractor, District, State, Construction Manager(s), Project Manager(s), and Architect(s) in amounts and including the provisions as set forth in the Supplementary Conditions (if any) and/or Special Conditions, and that complies with all requirements for Commercial General Liability and Automobile Liability and Employers' Liability Insurance.

13.1.3. **Subcontractor(s)**: Contractor shall require its Subcontractor(s), if any, to procure and maintain Commercial General Liability Insurance, Automobile Liability Insurance, and Umbrella Liability Insurance with minimum limits equal to the amounts required of the Contractor.

13.1.4. Workers' Compensation and Employers' Liability Insurance

13.1.4.1. In accordance with provisions of section 3700 of the California Labor Code, the Contractor and every Subcontractor shall be required to secure the payment of compensation to its employees.

13.1.4.2. Contractor shall procure and maintain, during the life of this Contract, Workers' Compensation Insurance and Employers' Liability Insurance for all of its employees engaged in Work under the Contract, on/or at the Site of the Project. This coverage shall cover, at a minimum, medical and surgical treatment, disability benefits, rehabilitation therapy, and survivors' death benefits. Contractor shall require its Subcontractor(s), if any, to procure and maintain Workers' Compensation Insurance and Employers' Liability Insurance for all employees of Subcontractor(s). Any class of employee or employees not covered by a Subcontractor's insurance shall be covered by Contractor's insurance. If any class of employee or employees engaged in Work under the Contract, on or at the Site of the Project, are not protected under the Workers' Compensation Insurance, Contractor shall provide, or shall cause a Subcontractor to provide, adequate insurance coverage for the protection of any employee(s) not otherwise protected before any of those employee(s) commence work.

13.1.5. Builder's Risk Insurance: Builder's Risk "All Risk" Insurance.

Contractor shall procure and maintain, during the life of this Contract, Builder's Risk (Course of Construction), or similar first party property coverage acceptable to the District, issued on a replacement cost value basis. The cost shall be consistent with the total replacement cost of all insurable Work included within the Contract Documents. Coverage is to insure against all risks of accidental physical loss and shall include without limitation the perils of vandalism and/or malicious mischief (both without any limitation regarding vacancy or occupancy), sprinkler leakage, civil authority, theft, sonic disturbance, earthquake, flood, collapse, wind, fire, war, terrorism, lightning, smoke, and rioting. Coverage shall

include debris removal, demolition, increased costs due to enforcement of all applicable ordinances and/or laws in the repair and replacement of damaged and undamaged portions of the property, and reasonable costs for the Architect's and engineering services and expenses required as a result of any insured loss upon the Work and Project, including completed Work and Work in progress, to the full insurable value thereof.

13.1.6. Proof of Carriage of Insurance and Other Requirements: Endorsements and Certificates

13.1.6.1. Contractor shall not commence Work nor shall it allow any Subcontractor to commence Work under the Contract, until Contractor and its Subcontractor(s) have procured all required insurance and Contractor has delivered in duplicate to the District complete endorsements (or entire insurance policies) and certificates indicating the required coverages have been obtained, and the District has approved these documents.

13.1.6.2. Endorsements, certificates, and insurance policies shall include the following:

13.1.6.2.1. A clause stating:

13.1.6.2.1.1. "This policy shall not be amended, canceled or modified and the coverage amounts shall not be reduced until notice has been mailed to District, Architect, and Construction Manager stating date of amendment, modification, cancellation or reduction. Date of amendment, modification, cancellation or reduction may not be less than thirty (30) days after date of mailing notice."

13.1.6.2.1.2. In lieu of receiving an endorsement with this clause, the District may, at its sole discretion, accept written notification from Contractor and its insurer to the District of any amendments, modifications, cancellations or reduction in coverage, not less than thirty (30) days prior to such coverage changes occur.

13.1.6.2.2. Language stating in particular those insured, extent of insurance, location and operation to which insurance applies, expiration date, to whom cancellation and reduction notice will be sent, and length of notice period.

13.1.6.3. All endorsements, certificates and insurance policies shall state that District, its trustees, employees and agents, the State of California, Construction Manager(s), Project Manager(s), Inspector(s) and Architect(s) are named additional insureds under all policies except Workers' Compensation Insurance and Employers' Liability Insurance.

13.1.6.4. Contractor's and Subcontractors' insurance policy(s) shall be primary and non-contributory to any insurance or self-insurance maintained by District, its trustees, employees and/or agents, the State of California, Construction Manager(s), Project Manager(s), Inspector(s), and/or Architect(s).

13.1.6.5. All endorsements shall waive any right to subrogation against any of the named additional insureds.

13.1.6.6. All policies shall be written on an occurrence form.

13.1.6.7. Unless otherwise stated in the Special Conditions, all of Contractor's insurance shall be with **admitted** insurance companies with an A.M. Best rating of no less than **A: VII**.

13.1.6.8. The insurance requirements set forth herein shall in no way limit the Contractor's liability arising out or relating to the performance of the Work or related activities.

13.1.6.9. Failure of Contractor and/or its Subcontractor(s) to comply with the insurance requirements herein shall be deemed a material breach of the Agreement.

13.1.7. Insurance Policy Limits

Unless different limits are indicated in the Special Conditions, the limits of insurance shall not be less than the following amounts:

Commercial General Liability	Combined Single Limit	\$1,000,000 per occurrence; \$2,000,000 aggregate
	Product Liability and Completed Operations	\$1,000,000 per occurrence; \$2,000,000 aggregate
Automobile Liability – Any Auto	Combined Single Limit	\$1,000,000 per occurrence; \$2,000,000 aggregate
Workers Compensation		Statutory limits pursuant to State law
Employers' Liability		\$2,000,000
Builder's Risk (Course of Construction)		Issued for the value and scope of Work indicated herein.

13.2. Contract Security – Bonds

13.2.1. Contractor shall furnish two surety bonds issued by a California admitted surety insurer as follows:

13.2.1.1. **Performance Bond:** A bond in an amount at least equal to one hundred percent (100%) of Contract Price as security for faithful performance of this Contract.

13.2.1.2. **Payment Bond:** A bond in an amount at least equal to one hundred percent (100%) of the Contract Price as security for payment of persons performing labor and/or furnishing materials in connection with the Contract.

13.2.2. Cost of bonds shall be included in the Bid and Contract Price.

13.2.3. All bonds related to the Project shall be in the forms set forth in the Contract Documents and shall comply with all requirements of the Contract Documents, including, without limitation, the bond forms.

14. WARRANTY/GUARANTEE/INDEMNITY

14.1. Warranty/Guarantee

14.1.1. Contractor shall obtain and preserve for the benefit of the District, manufacturer's warranties on materials, fixtures, and equipment incorporated into the Work.

14.1.2. In addition to guarantees required elsewhere, Contractor shall, and hereby does guarantee and warrant all Work against all defects for a period of **ONE (1)** year after the later of the following dates:

14.1.2.1. The date of completion as defined in Public Contract Code section 7107, subdivision (c),

14.1.2.2. The commissioning date for the Project, if any.

14.1.3. At the District's sole option, Contractor shall repair or replace any and all of that Work, together with any other Work that may be displaced in so doing, that may prove defective in workmanship and/or materials within a **ONE (1)** year period from date of Completion as defined above without expense whatsoever to District. In the event of failure of Contractor and/or Surety to commence and pursue with diligence said replacements or repairs within **TEN (10)** days after being notified in writing, Contractor and

Surety hereby acknowledge and agree that District is authorized to proceed to have defects repaired and made good at expense of Contractor and/or Surety who hereby agree to pay costs and charges therefore immediately on demand.

14.1.4. If, in the opinion of District, defective work creates a dangerous condition or requires immediate correction or attention to prevent further loss to District or to prevent interruption of operations of District, District will attempt to give the notice required above. If Contractor or Surety cannot be contacted or neither complies with District's request for correction within a reasonable time as determined by District, District may, notwithstanding the above provision, proceed to make all corrections and/or provide attentions the District believes are necessary. The costs of correction or attention shall be charged against Contractor and Surety of the guarantees provided in this Article or elsewhere in the Contract Documents.

14.1.5. The above provisions do not in any way limit the guarantees on any items for which a longer guarantee is specified or on any items for which a manufacturer gives a guarantee for a longer period. Contractor shall furnish to District all appropriate guarantee or warranty certificates as indicated in the Specifications or upon request by District.

14.1.6. Nothing herein shall limit any other rights or remedies available to District.

14.2. Indemnity

14.2.1. To the furthest extent permitted by California law, Contractor shall indemnify, defend with legal counsel reasonably acceptable to the District, keep and hold harmless the District and its consultants, the Architect and its consultants, the Construction Manager and its consultants, separate contractors, and their respective board members, officers, representatives, contractors, agents, and employees, in both individual and official capacities ("Indemnitees"), against all suits, claims, damages, losses, and expenses, including but not limited to attorney's fees, caused by, arising out of, resulting from, or incidental to, the performance of the Work by Contractor, its Subcontractors, vendors, or suppliers, including, without limitation, any such suit, claim, damage, loss, or expense attributable to, without limitation, bodily injury, sickness, disease, death, alleged patent violation or copyright infringement, or to injury to or destruction of tangible property (including damage to the Work itself) including the loss of use resulting therefrom, except to the extent caused by the sole negligence, active negligence, or willful misconduct of the Indemnitees, and/or to any extent that would render these provisions void or unenforceable. This agreement and obligation of Contractor shall not be construed to negate, abridge, or otherwise reduce any right or obligation of indemnity that would otherwise exist as to any party or person described herein. This indemnification, defense, and hold harmless obligation includes any failure or alleged failure by Contractor to comply with any provision of law, any failure or alleged failure to timely and properly fulfill all of its obligations under the Contract Documents in strict accordance with their terms, and without limitation, any stop payment notice actions or liens, including liens by the California Department of Labor Standards Enforcement.

14.2.2. Contractor shall give prompt notice to the District in the event of any injury (including death), loss, or damage included herein. Without limitation of the provisions herein, if Contractor's agreement to indemnify, defend, and hold harmless the Indemnitees as provided herein against liability for damage arising out of bodily injury to persons or damage to property caused by or resulting from the negligence of any of the Indemnitees shall to any extent be or be determined to be void or unenforceable, it is the intention of the parties that these circumstances shall not otherwise affect the validity or enforceability of Contractor's agreement to indemnify, defend, and hold harmless the rest of the Indemnitees, as provided herein, and in the case of any such suits, claims, damages, losses, or expenses caused in part by the default, negligence, or act or omission of Contractor, any Subcontractor, anyone directly or indirectly employed by any of them or anyone for whose acts any of them may be liable, and in part by any of the Indemnitees, Contractor shall be and remain fully liable on its agreements and obligations herein to the full extent permitted by law.

14.2.3. In any and all claims against any of the Indemnitees by any employee of Contractor, any Subcontractor, anyone directly or indirectly employed by any of them or anyone for whose acts any of them may be liable, Contractor's indemnification obligation herein shall not be limited in any way by any

limitation on the amount or type of damages, compensation, or benefits payable by or for Contractor or any Subcontractor under workers' compensation acts, disability benefit acts, or other employee benefit acts.

14.2.4. The defense and indemnification obligations hereunder shall survive the Completion of Work, including the warranty/guarantee period, and/or the termination of the Agreement.

15. TIME

15.1. Notice to Proceed

15.1.1. District may issue a Notice to Proceed as indicated in the Instructions to Bidders.

15.2. Hours of Work

15.2.1. Sufficient Forces

Contractor and Subcontractors shall continuously furnish sufficient forces to ensure the performance of the Work in accordance with the Construction Schedule.

15.2.2. Performance During Working Hours

Work shall be performed during regular working hours as permitted by the appropriate governmental agency except that in the event of an emergency, or when required to complete the Work in accordance with job progress, Work may be performed outside of regular working hours with the advance written consent of the District and approval of any required governmental agencies.

15.3. Progress and Completion

15.3.1. Time of the Essence

Time limits stated in the Contract Documents are of the essence to the Contract. By executing the Agreement, Contractor confirms that the Contract Time is a reasonable period for performing the Work.

15.3.2. No Commencement Without Insurance

15.3.2.1. Contractor shall not commence operations on the Project or elsewhere prior to the effective date of insurance and bonds. The date of commencement of the Work shall not be changed by the effective date of such insurance. If Contractor commences Work without insurance and bonds, all Work is performed at Contractor's peril and shall not be compensable until and unless Contractor secures bonds and insurance pursuant to the terms of the Contract Documents and subject to District's claim for damages.

15.4. Schedule

Contractor shall provide to District, Construction Manager, and Architect a schedule in conformance with the Contract Documents and as required in the Notice to Proceed and the Contractor's Submittals and Schedules section of these General Conditions.

15.5. Expeditious Completion

The Contractor shall proceed expeditiously with adequate forces and shall achieve Completion within the Contract Time.

16. EXTENSIONS OF TIME – LIQUIDATED DAMAGES

16.1. Contractor's Notice of Delay

16.1.1. In addition to the requirements indicated in this subsection, Contractor shall notify the District pursuant to the claims provisions in these General Conditions of any anticipated delay and its cause.

16.1.2. Contractor shall, within **FIVE (5)** calendar days of any delay impacting the critical path in completing the Work, notify District in writing of the causes of the delay including documentation and facts explaining the delay.

16.1.3. Any request by Contractor for an adjustment of the Contract Price or the Contract Time for a delay shall be submitted in accordance with the provisions in the Contract Documents governing changes in Work. When requesting time, requests must be submitted with full justification and documentation. Such justification must be based on the official Construction Schedule as updated at the time of occurrence of the delay or execution of Work related to any changes to the Scope of Work.

16.1.4. Any claim for delay must include the following information as support, without limitation:

16.1.4.1. The duration of the activity relating to the changes in the Work and the resources (manpower, equipment, material, etc.) required to perform the activities within the stated duration.

16.1.4.2. Specific logical ties to the Contract Schedule for the proposed changes and/or delay showing the activity/activities in the Construction Schedule that are affected by the change and/or delay. (A portion of any delay of seven (7) days or more must be provided.)

16.1.4.3. A recovery schedule must be submitted.

16.1.5. District shall review the facts and extent of any noticed delay and may grant Contract Time extension(s) of time for completing Work when, in the District's judgment, the findings of fact justify an extension.

16.1.6. Extension(s) of time shall apply only to that portion of Work affected by delay, and shall not apply to other portions of Work not so affected.

16.1.7. An extension of time may only be granted if Contractor has timely submitted the Construction Schedule as required herein.

16.1.8. Following submission of a notice of delay, the District may determine whether the delay is to be considered:

16.1.8.1. Excusable and Compensable, Excusable, or Unexcused;

16.1.8.2. How long the delay continues; and

16.1.8.3. To what extent the prosecution and Completion of the Work might be delayed thereby.

16.1.9. Contractor's failure to request adjustment(s) of the Contract Time in strict conformity with applicable provisions of the Contract Documents shall be deemed Contractor's waiver of its right to assert a claim for a delay.

16.2. Excusable and Compensable Delay(s)

16.2.1. Contractor is **not** entitled to additional compensation for any delay, even a delay caused by Adverse Weather or an Excusable Delay, unless **all** of the following conditions are met:

16.2.1.1. The District is responsible for the delay;

16.2.1.2. The delay is unreasonable under the circumstances involved and impacts the critical path of the Work and extends the most current Contract Completion date;

16.2.1.3. The delay was not within the contemplation of District and Contractor; and

16.2.1.4. Contractor complies with the claims procedure of the Contract Documents.

16.2.1.5. The delay could **not** have been avoided or mitigated by the Contractor's care, prudence, foresight, and diligence.

16.2.1.6. The delay extends the most current Contract Completion date, and is not concurrent with a Contractor caused delay or other type of Excusable Delay.

16.3. Excusable Delay(s)

16.3.1. An "Excusable Delay" shall mean an interruption of the Work beyond the reasonable control of the Contractor and that:

16.3.1.1. Could have not been avoided by the Contractor exercising care, prudence, foresight, and diligence, and

16.3.1.2. Actually extended the most current Project Completion date.

16.3.2. The Contractor may be entitled to an extension of the Project Completion date if there is an Excusable Delay, but the Contractor shall not be entitled to additional compensation for an Excusable Delay.

16.3.3. Excusable Delays are limited to interruptions that satisfy the above requirements and that are acts of God; acts of a public enemy; fires; floods; windstorms; tornadoes; earthquakes; wars; riots; insurrections; epidemics; quarantine restrictions; strikes; lockouts; fuel shortages; freight embargoes; and Adverse Weather that satisfies the requirements herein.

16.3.4. Contractor is aware that governmental agencies and utilities, including, without limitation, the Division of the State Architect, the Department of General Services, gas companies, electrical utility companies, water districts, and other agencies may have to approve Contractor-prepared drawings or approve a proposed installation. Contractor shall include in its bid, time for possible review of its drawings and for reasonable delays and damages that may be caused by such agencies. Contractor is not entitled to make a claim for damages or delays or an Excusable Delay arising from the review of Contractor's drawings or other approvals from the Division of the State Architect, the Department of General Services, gas companies, electrical utility companies, water districts, and other agencies.

16.3.5. Computation of Time / Adverse Weather

16.3.5.1. The Contractor will only be allowed a time extension for Adverse Weather conditions if requested by Contractor within five (5) calendar days of the Adverse Weather event, and only if **all** of the following conditions are met – thereby making the resulting delay an Excusable Delay.

16.3.5.1.1. The weather conditions constitute Adverse Weather, as defined herein and further specified in the Special Conditions;

16.3.5.1.2. Contractor can verify that the Adverse Weather caused delays in excess of five (5) hours of the indicated labor required to complete the scheduled tasks of Work on the day affected by the Adverse Weather;

16.3.5.1.3. The Contractor's crew is dismissed as a result of the Adverse Weather; and

16.3.5.1.4. The number of days of delay for the month exceed those indicated in the Special Conditions.

16.3.5.2. A day-for-day extension will only be allowed for those days in excess of those indicated in the Special Conditions.

16.3.5.3. The Contractor shall work seven (7) days per week, if necessary, irrespective of inclement weather, to maintain access and the Construction Schedule, and to protect the Work under construction from the effects of Adverse Weather, all at no further cost to the District.

16.3.5.4. The Contract Time has been determined with consideration given to the average climate weather conditions prevailing in the County in which the Project is located.

16.4. Unexcused Delay(s) – Liquidated Damages

16.4.1. Contractor and District hereby agree that the exact amount of damages for failure to complete the Work within the time specified is extremely difficult or impossible to determine. If the Work is not completed within the time specified in the Contract Documents, it is understood that the District will suffer damage. It being impractical and unfeasible to determine the amount of actual damage, it is agreed the Contractor shall forfeit to District as fixed and liquidated damages, and not as a penalty, the amount set forth in the Agreement for each calendar day of delay in Completion. Contractor and its Surety shall be liable for the amount thereof pursuant to Government Code section 53069.85.

16.4.2. Contractor shall not forfeit liquidated damages for an Excusable Delay or an Excusable and Compensable Delay.

17. CHANGES IN THE WORK

17.1. No Changes Without Authorization

17.1.1. There shall be no change whatsoever in the Drawings, Specifications, or in the Work without an executed Change Order, a written Construction Change Directive, or a written Force Account Directive authorized by the District as herein provided. District shall not be liable for the cost of any extra work, any changes to the Contract Time, or any substitutions, changes, additions, omissions, or deviations from the Drawings and Specifications unless the District's governing board has authorized the same and the cost thereof has been approved in writing by an executed Change Order, a written Construction Change Directive, or a written Force Account Directive.

17.1.2. The Surety, in executing and providing the Performance Bond and the Payment Bond, shall be deemed to have expressly agreed to any change to the Contract and to any extension of time made by reason thereof.

17.1.3. No extension of time for performance of the Work shall be allowed hereunder unless claim for such extension is made at the time changes in the Work are ordered, and such time duly adjusted in writing in the Change Order, Construction Change Directive, or Force Account Directive. The provisions of the Contract Documents shall apply to all such changes, additions, and omissions with the same effect as if originally embodied in the Drawings and Specifications.

17.1.4. Contractor shall perform immediately all work that has been authorized by a fully executed Change Order, Construction Change Directive, or Force Account Directive. Contractor shall be fully responsible for any and all delays and/or expenses caused by Contractor's failure to expeditiously perform this Work.

17.1.5. Should any Change Order result in an increase in the Contract Price, the cost of that Change Order shall be agreed to, in writing, in advance by Contractor and District and be subject to the monetary limitations set forth in Public Contract Code section 20118.4. In the event that Contractor proceeds with

any change in Work without a Change Order executed by the District, Construction Change Directive, or Force Account Directive, Contractor waives any claim of additional compensation or time for that additional work.

17.1.6. Contractor understands, acknowledges, and agrees that the reason for District authorization is so that District may have an opportunity to analyze the Work and decide whether the District shall proceed with the Change Order or alter the Project so that a change in Work becomes unnecessary.

17.1.7. No payments will be made, nor will District accept proposed change orders until the Contractor has complied with all the requirements of the Escrow of Bid Documentation document.

17.2. Architect Authority

The Architect will have authority to order minor changes in the Work not involving any adjustment in the Contract Price, or an extension of the Contract Time, or a change that is inconsistent with the intent of the Contract Documents. These changes shall be effected by written Change Order, Construction Change Directive, or by Architect's response(s) to RFI(s).

17.3. Change Orders

17.3.1. A Change Order is a written instrument prepared and issued by the District and/or the Architect and signed by the District (as authorized by the District's governing board), the Contractor, the Architect, and approved by the Project Inspector (if necessary) and DSA (if necessary), stating their agreement regarding all of the following:

17.3.1.1. A description of a change in the Work;

17.3.1.2. The amount of the adjustment in the Contract Price, if any; and

17.3.1.3. The extent of the adjustment in the Contract Time, if any.

17.3.2. If a Change Order is required to be approved by DSA, the District may call it a Construction Change Document.

17.3.3. If the District approves of a Change, the District or the Architect shall provide a written Change Order to the Contractor describing the Change and setting forth the adjustment to the Contract Time and the Contract Price, if any, on account of that Change. All Change Orders shall be full payment and final settlement of all rights for direct, indirect and consequential costs, including without limitation, costs of delays or impacts related to, or arising out of, items covered and affected by the Change Order, as well as any adjustments to the Contract Time. Any demand or request for an adjustment to the Contract Time or the Contract Price relating to any Change incorporated into a Change Order not presented by the Contractor for inclusion in the Change Order shall be deemed waived. The Contractor shall execute the Change Order prepared pursuant to the foregoing. After the Change Order has been prepared and forwarded to the Contractor for execution, the Contractor shall not modify or amend the form or content of such Change Order, or any portion thereof.

17.4. Construction Change Directives / Unilateral Change Orders

17.4.1. A Construction Change Directive (or Unilateral Change Order) is a written order prepared and issued by the District, the Construction Manager, and/or the Architect and signed by the District and the Architect, directing a change in the Work. The District may as provided by law, by Construction Change Directive and without invalidating the Contract, order changes in the Work consisting of additions, deletions, or other revisions. If all or a portion of the Project is being funded by funds requiring approval by the State Allocation Board (SAB), these revisions may be subject to compensation once approval of same is received and funded by the SAB, and funds are released by the Office of Public School Construction (OPSC). Any dispute as to the sum of the Construction Change Directive or timing of

payment shall be resolved pursuant to the Payment and Claims and Disputes provisions herein. A **Construction Change Directive** is NOT a **Construction Change Document** (which is defined above as a Change Order that DSA must approve).

17.4.2. The District may issue a Construction Change Directive in the absence of agreement on the terms of a Change Order.

17.5. Force Account Directives

17.5.1. When work, for which a definite price has not been agreed upon in advance, is to be paid for on a force account basis, all direct costs necessarily incurred and paid by the Contractor for labor, material, and equipment used in the performance of that Work, shall be subject to the approval of the District and compensation will be determined as set forth herein.

17.5.2. District will issue a Force Account Directive to proceed with the Work on a force account basis, and a not-to-exceed budget will be established by District.

17.5.3. All requirements regarding direct cost for labor, labor burden, material, equipment, and markups on direct costs for overhead and profit described in this section shall apply to Force Account Directives. However, District will only pay for actual costs verified in the field by the District or its authorized representative(s) on a daily basis.

17.5.4. Contractor shall be responsible for all cost related to the administration of Force Account Directive. The markup for overhead and profit for Contractor modifications shall be full compensation to the Contractor to administer Force Account Directive.

17.5.5. Contractor shall notify District or its authorized representative(s) at least twenty-four (24) hours prior to proceeding with any of the force account work. Furthermore, the Contractor shall notify the District when it has consumed eighty percent (80%) of the budget, and shall not exceed the budget unless specifically authorized in writing by the District. Contractor will not be compensated for force account work in the event that Contractor fails to timely notify the District regarding the commencement of force account work, or exceeding the force account budget.

17.5.6. Contractor shall diligently proceed with the work, and on a daily basis, submit a daily force account report on a form supplied by the District no later than 5:00 p.m. each day. The report shall contain a detailed itemization of the daily labor, material, and equipment used on the force account work only. The names of the individuals performing the force account work shall be included on the daily force account reports. The type and model of equipment shall be identified and listed. District will review the information contained in the reports, and sign the reports no later than the next work day, and return a copy of the report to Contractor for its records. District will not sign, nor will Contractor receive compensation for work District cannot verify. Contractor will provide a weekly force account summary indicating the status of each Force Account Directive in terms of percent complete of the not-to-exceed budget and the estimated percent complete of the work.

17.5.7. In the event Contractor and District reach a written agreement on a set cost for the work while the work is proceeding based on a Force Account Directive, the Contractor's signed daily force account reports shall be discontinued and all previously signed reports shall be invalid.

17.6. Price Request

17.6.1. **Definition of Price Request.** A Price Request ("PR") is a written request prepared by the Architect requesting the Contractor to submit to the District and the Architect an estimate of the effect of a proposed change in the Work on the Contract Price and the Contract Time.

17.6.2. **Scope of Price Request.** A Price Request shall contain adequate information, including any necessary Drawings and Specifications, to enable Contractor to provide the cost breakdowns required

herein. Contractor shall not be entitled to any additional compensation for preparing a response to a Price Request, whether ultimately accepted or not.

17.7. Proposed Change Order

17.7.1. Definition of Proposed Change Order. A Proposed Change Order ("PCO") is a written request prepared by the Contractor requesting that the District and the Architect issue a Change Order based upon a proposed change to the Work.

17.7.2. Changes in Contract Price. A PCO shall include breakdowns pursuant to the provisions herein to validate any change in Contract Price.

17.7.3. Changes in Time. A PCO shall also include any changes in time required to complete the Project. Any additional time requested shall not be the number of days to make the proposed change, but must be based upon the impact to the Construction Schedule as defined in the Contract Documents. If Contractor fails to request a time extension in a PCO, then the Contractor is thereafter precluded from requesting time and/or claiming a delay.

17.7.4. Unknown and/or Unforeseen Conditions. If Contractor submits a PCO requesting an increase in Contract Price and/or Contract Time that is based at least partially on Contractor's assertion that Contractor has encountered unknown and/or unforeseen condition(s) on the Project, then Contractor shall base the PCO on provable information that, beyond a reasonable doubt and to the District's satisfaction, demonstrates that the unknown and/or unforeseen condition(s) were actually unknown and/or unforeseen and that the condition(s) were reasonably unknown and/or unforeseen. If not, the District shall deny the PCO and the Contractor shall complete the Project without any increase in Contract Price and/or Contract Time based on that PCO.

17.7.5. Time to Submit PCO. Contractor shall submit its PCO within five (5) days of the date Contractor discovers, or reasonably should discover, the circumstances giving rise to the proposed change order, unless additional time to submit a proposed change order is granted in writing by the District.

17.8. Format for Proposed Change

17.8.1. The following "Format For Proposed Change For Subcontractor Performed Work" and "Format For Proposed Change For Contractor Performed Work" shall be used as applicable by the District and the Contractor (e.g. Change Orders, PCO's) to communicate proposed additions and deductions to the Contract, supported by attached documentation

FORMAT FOR PROPOSED CHANGE FOR SUBCONTRACTOR PERFORMED WORK

	SUBCONTRACTOR PERFORMED WORK	ADD	DEDUCT
(A)	<p><u>Labor Charge</u></p> <p>1. Hours. Attach total itemized hours.</p> <p>2. Rate. This shall be no more than the Straight-Time Total Hourly Rate as determined by the Department of Industrial Relations ("DIR") for the applicable labor category.</p>		
(B)	<p><u>Labor Burden & Worker's Compensation Charge</u></p> <p>1. This shall be no more than twenty percent (20%) of item (A), the Labor Charge.</p> <p>2. This shall be the total cumulative charge permitted for all Subcontractors or all labor performed by the Subcontractor or Subcontractor's Subcontractor(s) (i.e., all "lower-tier" Subcontractor(s)).</p>		
(C)	Subtotal (A+B)		
(D)	<p><u>Material Charge</u></p> <p>Attach itemized quantity and unit cost plus sales tax and invoice(s) from vendor(s).</p>		
(E)	<p><u>Equipment Charge</u></p> <p>Attach invoice(s) from supplier(s).</p>		
(F)	Subtotal (C+D+E)		
(G)	<p><u>Subcontractor's Overhead and Profit Charge</u></p> <p>1. This shall be no more than five percent (5%) of item (F).</p> <p>2. This shall be the total cumulative mark-up permitted for the Subcontractor and Subcontractor's Subcontractor(s) (i.e., all "lower-tier" Subcontractor(s)).</p>		
(H)	Subtotal (F+G)		
(I)	<p><u>Contractor's Overhead, Profit, Bond and Insurance</u></p> <p>1. This shall be no more than six percent (6%) of Item (H).</p> <p>2. This shall be the total mark-up permitted for Contractor.</p>		
(J)	Subtotal (H+I)		
(K)	<u>Time</u>	Days	
(L)	<p><u>Contractor's Home Office Overhead</u></p> <p>This shall be no more than \$200 times the number of days of Item (K) (i.e., not to exceed \$200/day)</p>		
(M)	TOTAL (J+L)		

FORMAT FOR PROPOSED CHANGE FOR CONTRACTOR PERFORMED WORK

	CONTRACTOR PERFORMED WORK	ADD	DEDUCT
(A)	<u>Labor Charge</u> 1. Hours. Attach total itemized hours. 2. Rate. This shall be no more than the Straight-Time Total Hourly Rate as determined by the Department of Industrial Relations ("DIR") for the applicable labor category.		
(B)	<u>Labor Burden & Worker's Compensation Charge</u> 1. This shall be no more than twenty percent (20%) of item (A), the Labor Charge. 2. This shall be the total cumulative charge permitted for all labor performed by Contractor.		
(C)	Subtotal (A+B)		
(D)	<u>Material Charge</u> Attach itemized quantity and unit cost plus sales tax and invoice(s) from vendor(s).		
(E)	<u>Equipment Charge</u> Attach invoice(s) from supplier(s).		
(F)	Subtotal (C+D+E)		
(G)	<u>Contractor's Overhead, Profit, Bond and Insurance</u> 1. This shall be no more than six percent (6%) of Item (F). 2. This shall be the total mark-up permitted for Contractor.		
(H)	Subtotal (F+G)		
(I)	Time		Days
(J)	<u>Contractor's Home Office Overhead</u> This shall be no more than \$200 times the number of days of Item (I) (i.e., not to exceed \$200/day)		
(M)	TOTAL (H+J)		

17.8.2. All proposed cost requests by Contractor for a change shall include a complete itemized breakdown with the following detail:

17.8.2.1. Labor. Labor breakdown by trade classification, wage rates, and estimated hours. Labor costs shall only include fringe benefits indicated by governing trade organizations. Wages shall not exceed current prevailing wages in the locality for performance of the changes.

17.8.2.1.1. The Contractor's or Subcontractors' labor burden and Workers' Compensation premium shall only be charged as indicated herein. In no event shall Contractor include any other charges than as indicated herein without the prior written approval of the District.

17.8.2.2. Material. Material quantities, and types of products, and transportation costs, if applicable.

17.8.2.3. Equipment. Equipment breakdown by make, type, size, rental rates, equipment hours and transportation costs, if applicable.

17.8.2.3.1. The equipment costs shall not exceed one hundred percent (100%) of the Association of Equipment Distributors (AED) rental rates or Caltrans rates, whichever is less. Hourly, daily, weekly, or monthly rates shall be used, whichever is lower. Hourly rates including operator shall not be used.

17.8.2.3.2. The actual time to be paid for equipment shall be the time that the equipment is in productive operation on the Work under Contract Modification. In computing the hourly rental of equipment, any time less than thirty (30) minutes shall be considered one-half (1/2) hour. No payment will be made for time while equipment is inoperative due to breakdown, or for non-workdays. In addition, the rental time shall not include the time required to move the equipment to and from the project site. No mobilization or demobilization will be allowed for equipment already on site. If such equipment is not moved by its own power, then loading and transportation costs will be paid in lieu of rental time thereof. However, neither moving time nor loading and transportation costs will be paid if the equipment is used on the Project Site in any other way than upon the work directly related to the Contract Modification.

17.8.2.3.3. Individual pieces of equipment having a replacement value of one thousand dollars (\$1,000) or less shall be considered to be small tools or small equipment, and no payment will be made since the costs of these tools and equipment is included as part of the markup for overhead and profit defined herein.

17.8.2.3.4. Payment to the Contractor for the use of equipment as set forth above shall constitute full compensation to the Contractor for the cost of fuel, power, oil, lubricants, supplies, small equipment, necessary attachments, repairs and maintenance of any kind, depreciation, storage, insurance, labor (except for equipment operators), and any and all costs to the Contractor incidental to the use of the equipment.

17.8.2.3.5. Should Contractor, or any of its owners, officers, directors or agents, hold any ownership interest in any company, organization, association or corporation from whom rental equipment is secured. Contractor shall immediately notify District of such and the price set for any such rental shall be agreed upon in advance by the Contractor and the District.

17.8.2.3.6. Overhead and Profit. Markup for overhead and profit, which shall be used to compensate Contractor for all costs for all administration, general conditions, and supervision, including, without limitation:

17.8.2.3.6.1. All field, field office and home office personnel including, but not limited to, principals, project managers, superintendents, supervisory foremen, estimators,

project engineers, detailers, draftsmen, schedulers, consultants, watchmen, payroll clerks, administrative assistants, labor compliance costs and secretaries.

17.8.2.3.6.2. All field, field office and home office expenses including, but not limited to, field trailers, parking, storage sheds, office equipment and supplies, telephone service and long distance telephone calls, fax machines, temporary utilities, sanitary facilities and services, janitorial services, small tools and equipment with a cost under \$1000 each, portable scaffolding, blocking, shores, appliances, job vehicles, security and fencing, conformance to regulatory requirements including compliance to safety regulations, safety programs and meetings, cartage, warranties, As-Built Drawings, as well as any related maintenance costs.

17.8.2.3.6.3. Administrative functions such as, but not limited to, reviewing, coordinating, distributing, processing, posting, recording, estimating, negotiating, expediting, engineering, drawing, detailing, revising shop drawings, carting, cleaning, protecting the work, and other incidental Work related to the change.

17.8.2.3.6.4. All other costs and taxes required to be paid, but not included under direct costs as defined above including, without limitation, payroll taxes, social security, etc.

17.8.2.3.6.5. All costs for Contractor's bonds and insurance.

17.8.2.3.6.6. Taxes: Federal excise tax shall not be included. District will issue an exemption on request.

17.8.2.3.7. Justification for any adjustment in Contract Time including a schedule analysis identifying critical schedule activities delayed by the request.

17.9. Change Order Certification

17.9.1. All Change Orders and PCOs shall include the following certification by the Contractor. The Parties acknowledged that if a Change Order is approved that does not include this language, that Change Order shall be deemed to include this certification language:

The Contractor approves the foregoing as to the changes, if any, and the price specified for each item and the extension of time allowed, if any, for completion of the entire Work as stated herein, and agrees to furnish all labor, materials, and service, and perform all work necessary to complete all additional work specified for the consideration stated herein. Submission of sums which have no basis in fact or which Contractor knows are false are at the sole risk of Contractor and may be a violation of the False Claims Act set forth under Government Code section 12650 et seq. It is understood that the changes herein to the Contract shall only be effective when approved by the governing board of the District. It is expressly understood that the value of the extra Work or changes includes all of the Contractor's costs, expenses, field overhead, home office overhead, profit, both direct and indirect, resulting from additional time required on the Project or resulting from delay to the Project. Any costs, expenses, damages, or time extensions not included are deemed waived.

17.10. Determination of Change Order Cost

17.10.1. The amount of the increase or decrease in the Contract Price from a Change Order, if any, shall be determined in one or more of the following ways as applicable to a specific situation and at the District's discretion:

- 17.10.1.1. District acceptance of a PCO;
- 17.10.1.2. By unit prices contained in Contractor's original bid;
- 17.10.1.3. By agreement between District and Contractor.

17.11. Deductive Change Orders

If Contractor offers a proposed amount for a deductive Change Order(s), Contractor shall include a minimum of five percent (5%) total overhead and profit to be deducted with the amount of the work of the Change Order(s). If Subcontractor work is involved, Subcontractors shall also include a minimum of five percent (5%) overhead and profit to be deducted with the amount of its deducted work, for a total minimum of ten percent (10%) total overhead and profit to be deducted. Any deviation from this provision shall not be allowed.

17.12. Discounts, Rebates and Refunds

For purposes of determining the cost, if any, of any change, addition, or omission to the Work hereunder, all trade discounts, rebates, refunds, and all returns from the sale of surplus materials and equipment shall accrue and be credited to the Contractor, and the Contractor shall make provisions so that such discounts, rebates, refunds, and returns may be secured, and the amount thereof shall be allowed as a reduction of the Contractor's cost in determining the actual cost of construction for purposes of any change, addition, or omission in the Work as provided herein.

17.13. Accounting Records

With respect to portions of the Work performed by Change Orders and Construction Change Directives, Contractor shall keep and maintain cost-accounting records satisfactory to the District, which shall be available to the District on the same terms as any other books and records Contractor is required to maintain pursuant to the Contract Documents.

17.14. Notice Required

If Contractor is seeking an adjustment in the Contract Price, or any extension in the Contract Time for Completion, it shall notify District pursuant to the provisions of the Contract Documents. No adjustment in the Contract Price or Contract Time shall be considered unless made in accordance with the Contract Documents. Contractor shall proceed to execute the Work even though the adjustment may not have been agreed upon. Any change in the Contract Price or extension of the Contract Time resulting from such contract adjustment shall only be authorized by a Change Order.

17.15. Applicability to Subcontractors

Any requirements under this Article shall be equally applicable to Change Orders or Construction Change Directives issued to Subcontractors by the Contractor to the extent as required by the Contract Documents.

17.16. Alteration to Change Order Language

Contractor shall not alter Change Orders or reserve time in Change Orders. Contractor shall execute finalized Change Orders and proceed under the provisions herein with proper notice.

17.17. Failure of Contractor to Execute Change Order

Contractor shall be in default of the Contract if Contractor fails to execute a Change Order when the Contractor agrees with the addition and/or deletion of the Work in that Change Order.

18. REQUEST FOR INFORMATION

- 18.1. Any Request for Information ("RFI") shall reference all applicable Contract Document(s), including Specification section(s), detail(s), page number(s), drawing number(s), and sheet number(s), etc. Contractor shall make suggestions and interpretations of the issue raised by each RFI. An RFI cannot modify the Contract Price, Contract Time, or the Contract Documents.
- 18.2. Contractor shall be liable to the District for all costs incurred by the District associated with the processing, reviewing, evaluating and responding to any RFI, including without limitation, fees of the Architect and any other design consultant to the Architect or the District, that District reasonably determines:
- 18.2.1. Does not reflect adequate or competent supervision or coordination by the Contractor or any Subcontractor; or
- 18.2.2. Does not reflect the Contractor's adequate or competent knowledge of the requirements of the Work or the Contract; or
- 18.2.3. Requests an interpretation or decision of a matter where the information sought is equally available to the Contractor; or
- 18.2.4. Is not justified for any other reason.
- 18.3. Prior to submitting the RFI, Contractor shall diligently review the Contract Documents for information responsive to the RFI, including information incorporated by reference. Contractor should not issue an RFI regarding information contained in or inferable from the Contract Documents, including information incorporated by reference. An RFI is invalid if the RFI response is contained in or inferable from the Contract Documents.
- 18.4. Contractor shall be responsible for preparing and submitting each RFI so as to not cause delay to the progress of the Work nor to cause any impact to the Contractor's labor productivity. An RFI may be considered untimely if not submitted within **Forty Eight (48) hours** of receipt from a Contractor's subcontractor. Untimely submission of any RFI will preclude Contractor from asserting any claims for delay or for labor impact against the District.

19. PAYMENTS

19.1. Contract Price

19.1.1. The Contract Price is stated in the Agreement and, including authorized adjustments, is the total amount payable by the District to the Contractor for performance of the Work pursuant to the Contract Documents.

19.2. Applications for Progress Payments

19.2.1. Procedure for Applications for Progress Payments

19.2.1.1. Application for Progress Payment

19.2.1.1.1. Not before the fifth (5th) day of each calendar month during the progress of the Work, Contractor shall submit to the District and the Architect an itemized Application for Payment for Work completed in accordance with the Schedule of Values. The Application for Payment shall be notarized, if required, and supported by the following or each portion thereof unless waived by the District in writing:

19.2.1.1.1.1. The amount paid to the date of the Application for Payment to the Contractor, to all its Subcontractors, and all others furnishing labor, material, or equipment for its Contract;

- 19.2.1.1.1.2. The amount being requested by the Application for Payment by the Contractor on its own behalf and separately stating the amount requested on behalf of each of the Subcontractors and all others furnishing labor, material, and equipment under the Contract;
- 19.2.1.1.1.3. The balance that will be due to each of the entities after payment is made;
- 19.2.1.1.1.4. A certification that the As-Built Drawings and annotated Specifications are current;
- 19.2.1.1.1.5. An Itemized breakdown of Work performed;
- 19.2.1.1.1.6. An updated and acceptable construction schedule in conformance with the provisions herein;
- 19.2.1.1.1.7. The additions to and subtractions from the Contract Price and Contract Time;
- 19.2.1.1.1.8. A total of the retentions held;
- 19.2.1.1.1.9. The material invoices, evidence of equipment purchases, rentals, and other support and details of cost as the District may require from time to time;
- 19.2.1.1.1.10. The percentage of completion of the Contractor's Work by line item;
- 19.2.1.1.1.11. The Schedule of Values updated from the preceding Application for Payment;
- 19.2.1.1.1.12. A duly completed and executed conditional waiver and release upon progress payment compliant with Civil Code section 8132 from each subcontractor of any tier and supplier to be paid from the current progress payment;
- 19.2.1.1.1.13. A duly completed and executed unconditional waiver and release upon progress payment compliant with Civil Code section 8134 from each subcontractor of any tier and supplier that was paid from the previous progress payment; and
- 19.2.1.1.1.14. A certification by the Contractor of the following:
- 19.2.1.1.1.15. *The Contractor warrants title to all Work performed as of the date of this payment application. The Contractor further warrants that all Work performed as of the date of this payment application is free and clear of liens, claims, security interests, or encumbrances in favor of the Contractor, Subcontractors, material and equipment suppliers, workers, or other persons or entities making a claim by reason of having provided labor, materials, and equipment relating to the Work, except those of which the District has been informed.* If requested by the District, a third party, or as required by the California Department of Industrial Relations all requested or required certified payroll record ("CPR(s)") for each journeyman, apprentice, worker, or other employee employed by the Contractor and/or each Subcontractor in connection with the Work for the period of the Application for Payment.

19.2.1.1.2. Contractor shall be subject to the False Claims Act set forth under Government Code section 12650 et seq., for information provided with any Application for Progress Payment.

19.2.2. Prerequisites for Progress Payments

19.2.2.1. First Payment Request: The following items, if applicable, must be completed before District will accept and/or process Contractor's first payment request:

- 19.2.2.1.1. Installation of the Project sign;
- 19.2.2.1.2. Installation of field office;
- 19.2.2.1.3. Installation of temporary facilities and fencing;
- 19.2.2.1.4. Schedule of Values;
- 19.2.2.1.5. Contractor's Construction Schedule;
- 19.2.2.1.6. Schedule of unit prices, if applicable;
- 19.2.2.1.7. Submittal Schedule;
- 19.2.2.1.8. Receipt by Architect of all submittals due as of the date of the payment application;
- 19.2.2.1.9. Copies of necessary permits;
- 19.2.2.1.10. Copies of authorizations and licenses from governing authorities;
- 19.2.2.1.11. Initial progress report;
- 19.2.2.1.12. Surveyor qualifications;
- 19.2.2.1.13. Written acceptance of District's survey of rough grading, if applicable;
- 19.2.2.1.14. List of all Subcontractors, with names, license numbers, telephone numbers, and Scope of Work;
- 19.2.2.1.15. All bonds and insurance endorsements; and
- 19.2.2.1.16. Resumes of Contractor's project manager, and if applicable, job site secretary, record documents recorder, and job site superintendent.

19.2.2.2. Second Payment Request: District will not process the second payment request until and unless all submittals and Shop Drawings have been accepted for review by the Architect.

19.2.2.3. No Waiver of Criteria: Any payment made to Contractor where criteria set forth herein have not been met shall not constitute a waiver of said criteria by District. Instead, such payment shall be construed as a good faith effort by District to resolve differences so Contractor may pay its Subcontractors and suppliers. Contractor agrees that failure to submit such items may constitute a material breach of the Contract by Contractor and may subject Contractor to termination.

19.3. Progress Payments

19.3.1. District's Approval of Application for Payment

19.3.1.1. Upon receipt of an Application for Payment, District shall act in accordance with the following:

- 19.3.1.1.1. Each Application for Payment shall be reviewed by the District as soon as practicable after receipt for the purpose of determining that the Application for Payment is a proper Application for Payment.

19.3.1.1.2. Any Application for Payment determined not to be a proper Application for Payment suitable for payment shall be returned to the Contractor as soon as practicable, but not later than seven (7) days, after receipt. An Application for Payment returned pursuant to this paragraph shall be accompanied by a document setting forth in writing the reasons why the Application for Payment is not proper. The number of days available to the District to make a payment without being subject to any applicable statute regarding prompt payment or interest accrual, shall be reduced by the number of days by which the District exceeds this seven-day return requirement.

19.3.1.1.3. An approved Application for Payment shall be considered payable if funds are available for payment after the deduction of amounts allowed by law and/or pursuant to the section herein entitled "Decisions to Withhold Payment,"

19.3.1.2. The District's review of the Contractor's Application for Payment will be based on the District's and the Architect's observations at the Site and the data comprising the Application for Payment that the Work has progressed to the point indicated and that, to the best of the District's and the Architect's knowledge, information, and belief, the quality of the Work is in accordance with the Contract Documents. The foregoing representations are subject to:

19.3.1.2.1. Observation of the Work for general conformance with the Contract Documents,

19.3.1.2.2. Results of subsequent tests and inspections,

19.3.1.2.3. Minor deviations from the Contract Documents correctable prior to Completion, and

19.3.1.2.4. Specific qualifications expressed by the Architect.

19.3.1.3. District's approval of each Application for Payment shall be based on Contractor complying with all requirements for a fully complete and valid Application for Payment.

19.3.2. Payments to Contractor

19.3.2.1. Within thirty (30) days after approval of the Application for Payment, Contractor shall be paid a sum equal to ninety-five percent (95%) of the value of the Work performed (as verified by Architect and Inspector and certified by Contractor) up to the last day of the previous month, less the aggregate of previous payments and amount to be withheld. The value of the Work completed shall be Contractor's best estimate. No inaccuracy or error in Contractor's estimate shall operate to release the Contractor, or any Surety upon any bond, from damages arising from such Work, or from the District's right to enforce each and every provision of this Contract, and the District shall have the right subsequently to correct any error made in any estimate for payment.

19.3.2.2. District shall withhold five percent (5%) retention from all Progress Payments.

19.3.2.3. District may withhold ten percent (10%) retention from all Progress Payments pursuant to Public Contract Code section 7201, if the Project is determined to be "substantially complex."

19.3.2.4. The Contractor shall not be entitled to have any payment requests processed, or be entitled to have any payment made for Work performed, so long as any lawful or proper direction given by the District concerning the Work, or any portion thereof, remains incomplete.

19.3.3. No Waiver

No payment by District hereunder shall be interpreted so as to imply that District has inspected, approved, or accepted any part of the Work. Notwithstanding any payment, the District may enforce each and every provision of this Contract. The District may correct or require correction of any error subsequent to any payment.

19.3.4. Warranty of Title

19.3.4.1. If a lien or a claim based on a stop notice or stop payment notice of any nature should at any time be filed against the Work or any District property, by any entity that has supplied material or services at the request of the Contractor, Contractor and Contractor's Surety shall promptly, on demand by District and at Contractor's and Surety's own expense, take any and all action necessary to cause any such lien or a claim based on a stop notice or stop payment notice to be released or discharged immediately therefrom.

19.3.4.2. If the Contractor fails to furnish to the District within ten (10) calendar days after demand by the District, satisfactory evidence that a lien or a claim based on a stop notice or stop payment notice has been so released, discharged, or secured, the District may discharge such indebtedness and deduct the amount required therefore, together with any and all losses, costs, damages, and attorney's fees and expense incurred or suffered by District from any sum payable to Contractor pursuant to the Contract.

19.4. Decisions to Withhold Payment

19.4.1. Reasons to Withhold Payment

District may withhold payment in whole, or in part, to the extent reasonably necessary to protect the District if, in the District's opinion, the representations to the District required herein cannot be made. District may withhold payment, in whole, or in part, to such extent as may be necessary to protect the District from loss because of, but not limited to:

19.4.1.1. Defective Work not remedied within **FORTY-EIGHT (48)** hours of written notice to Contractor;

19.4.1.2. Stop notices, stop payment notices or other liens served upon the District as a result of the Contract;

19.4.1.3. Liquidated damages assessed against the Contractor;

19.4.1.4. The cost to complete the Work if there exists reasonable doubt that the Work can be completed for the unpaid balance of the Contract Price or by the Completion Date;

19.4.1.5. Damage to the District or other contractor(s);

19.4.1.6. Unsatisfactory performance of the Work by Contractor;

19.4.1.7. Failure to store and properly secure materials;

19.4.1.8. Failure of the Contractor to submit, on a timely basis, proper, sufficient, and acceptable documentation required by the Contract Documents, including, without limitation, a Construction Schedule, Schedule of Submittals, Schedule of Values, Monthly Progress Schedules, Shop Drawings, Product Data and samples, Proposed product lists, executed Change Orders, and/or verified reports;

19.4.1.9. Failure of the Contractor to maintain As-Built Drawings;

19.4.1.10. Erroneous estimates by the Contractor of the value of the Work performed, or other false statements in an Application for Payment;

19.4.1.11. Unauthorized deviations from the Contract Documents;

19.4.1.12. Failure of the Contractor to perform the Work in a timely manner in compliance with the Construction Schedule, established progress schedules, and/or completion dates;

19.4.1.13. If requested by the District, or the failure to provide to the DIR, certified payroll records acceptable to the District and the DIR for each journeyman, apprentice, worker, or other employee employed by the Contractor and/or each Subcontractor in connection with the Work for the period of the Application for Payment;

19.4.1.14. Failure to properly pay prevailing wages as defined in Labor Code sections 1720 et seq. and/or failure to comply with any other Labor Code requirements;

19.4.1.15. Failure to properly maintain or clean up the Site;

19.4.1.16. Failure to timely indemnify, defend or hold harmless the District;

19.4.1.17. Any payments due to the District, including but not limited to payments for failed tests, utilities changes, or permits;

19.4.1.18. Failure to pay Subcontractor(s) or supplier(s) as required by law and by the Contract Documents;

19.4.1.19. Failure to pay any royalty, license or similar fees;

19.4.1.20. Failure of the Contractor to submit on a timely basis all Closeout Documentation in a manner and form that is proper, sufficient, and reasonably acceptable to the District, and to not cause a delay in the Completion or approval of the Project; or

19.4.1.21. Failure to perform any implementation and/or monitoring required by any SWPPP for the Project and/or the imposition of any penalties or fines imposed therefore against Contractor or District.

19.4.1.22. Payment is delayed due to an audit inquiry by the State, the County Office of Education, the County, or any entity with jurisdiction related to the Project.

19.4.1.23. Contractor is otherwise in breach, default or in substantial violation of any provision of the Contract;

19.4.2. Reallocation of Withheld Amounts

19.4.2.1. District may, in its discretion, apply any withheld amount to pay outstanding claims or obligations as defined herein. In so doing, District shall make such payments on behalf of Contractor. If any payment is so made by District, then that amount shall be considered a payment made pursuant to the Contract and District shall not be liable to Contractor for any payment made in good faith. These payments may be made without prior judicial determination of claim or obligation. District will render Contractor an accounting of funds disbursed on behalf of Contractor.

19.4.2.2. If Contractor defaults or neglects to perform the Work in accordance with the Contract Documents or fails to perform any provision thereof, District may, after **FORTY-EIGHT (48)** hours written notice to the Contractor and, without prejudice to any other remedy, make good such deficiencies. District shall adjust the total Contract Price by reducing the amount thereof by the cost of making good such deficiencies. If District deems it inexpedient to correct Work that is damaged, defective, or not done in accordance with Contract provisions, an equitable reduction in the Contract Price (of at least one hundred twenty-five percent (125%) of the estimated reasonable value of the nonconforming Work) shall be made therefor.

19.4.3. Payment After Cure

When Contractor cures the grounds for declining approval, payment shall be made for amounts so withheld. No interest shall be paid on any retention or amounts withheld due to the failure of the Contractor to perform in accordance with the terms and conditions of the Contract Documents.

19.5. Subcontractor Payments

19.5.1. Payments to Subcontractors. No later than seven (7) days after receipt, or pursuant to Business and Professions Code section 7108.5 and Public Contract Code section 7107, the Contractor shall pay to each Subcontractor, out of the amount paid to the Contractor on account of such Subcontractor's portion of the Work, the amount to which said Subcontractor is entitled. Contractor shall, by appropriate agreement with each Subcontractor, require each Subcontractor to make payments to its Sub-subcontractors in a similar manner.

19.5.2. No Obligation of District for Subcontractor Payment. District shall have no obligation to pay, or to see to the payment of, money to a Subcontractor except as may otherwise be required by law.

19.5.3. Joint Checks. District shall have the right in its sole discretion, if necessary for the protection of the District, to issue joint checks made payable to the Contractor and Subcontractors and material or equipment suppliers. The joint check payees shall be responsible for the allocation and disbursement of funds included as part of any such joint payment. In no event shall any joint check payment be construed to create any contract between the District and a Subcontractor of any tier, any obligation from the District to such Subcontractor, or rights in such Subcontractor against the District.

20. COMPLETION OF THE WORK

20.1. Completion

20.1.1. The Project may only be accepted by action of the governing board of the District.

20.1.2. District shall accept the Project and may have a Notice of Completion recorded when Project Completion has been achieved in accordance with the Contract Documents and to the satisfaction of District. For purposes of the payment of Retention, Completion is defined in Public Contract Code section 7107. For purposes of the timely filing of Stop Payment Notices, Completion is defined in California Civil Code section 9200, et seq.

20.1.3. Although there is no "substantial completion" for this Project, the District, at its sole option, may accept the Project and record a Notice of Completion when Project Completion has been completed to the satisfaction of District, except for minor corrective items, as distinguished from incomplete items. If Contractor fails to complete all minor corrective items within thirty-five (35) days after the date of the District's acceptance of the Project, District shall withhold from the final payment one hundred fifty percent (150%) of an estimate of the amount sufficient to complete the corrective items, as determined by District, until the item(s) are completed.

20.1.4. At the end of the thirty-five (35) day period, if there are any items remaining to be corrected, District may elect to proceed as provided herein related to adjustments to Contract Price, and/or District's right to perform the Work of the Contractor.

20.2. Closeout Procedures

20.2.1. Punch List

Contractor shall notify the Architect when Contractor considers the Work complete. Upon notification, Architect will prepare a list of minor items to be completed or corrected ("Punch List"). Contractor and/or its Subcontractors shall proceed promptly to complete and correct items on the Punch List. Failure to include an item on Punch List does not alter the responsibility of the Contractor to complete all Work in accordance with the Contract Documents.

20.2.2. Closeout Requirements

20.2.2.1. Utility Connections

Buildings shall be connected to water, gas, sewer, and electric services, complete and ready for use. Service connections shall be made and existing services reconnected.

20.2.2.2. As-Built Drawings

20.2.2.2.1. In addition to its requirement to provide monthly As-Built Drawings to the District, the Contractor shall provide a final set of As-Built Drawings, sometimes referred to as "Record Drawings," showing all of the Work as actually constructed upon Completion of the Project as indicated in the Specifications.

20.2.2.2.2. Contractor is liable and responsible for any and all inaccuracies in the As-Built Drawings, even if inaccuracies become evident at a future date.

20.2.2.2.3. Upon Completion of the Work and as a condition precedent to approval of final payment, Contractor shall obtain the Inspector's approval of the final set of As-Built Drawings.

20.2.2.3. Operations & Maintenance Manuals: Contractor shall prepare all operation and maintenance manuals and date as indicated in the Specifications.

20.2.2.4. Closeout Documentation: Contractor shall provide all Closeout Documentation, which shall include the following, without limitation:

20.2.2.4.1. A full set of final As-Built Drawings, as further defined herein.

20.2.2.4.2. All Operations & Maintenance Manuals and information, as further defined herein.

20.2.2.4.3. All Warranties, as further defined herein.

20.2.2.4.4. Verified report(s) for all scope(s) of work (DSA 6-C, Rev 03/22/13, or more recent revision if available).

20.3. Final Inspection

20.3.1. Contractor shall comply with Punch List procedures as provided herein, and maintain the presence of a Project Superintendent and Project Manager until the Punch List is complete to ensure proper and timely completion of the Punch List. Under no circumstances shall Contractor demobilize its forces prior to completion of the Punch List. Upon receipt of Contractor's written notice that all of the Punch List items have been fully completed and the Work is ready for final inspection and acceptance, Architect and Project Inspector will inspect the Work and shall submit to Contractor and District a final inspection report noting the Work, if any, required in order to complete in accordance with the Contract Documents. Absent unusual circumstances, this report shall consist of the Punch List items not yet satisfactorily completed.

20.3.2. Upon Contractor's completion of all items on the Punch List and any other uncompleted portions of the Work, the Contractor shall notify the District and Architect, who shall again inspect such Work. If the Architect finds the Work complete and acceptable under the Contract Documents, the Architect will notify Contractor, who shall then jointly submit to the Architect and the District its final Application for Payment.

20.3.3. Final Inspection Requirements

20.3.3.1. Before calling for final inspection, Contractor shall determine that the following have been performed:

20.3.3.1.1. The Work has been completed.

20.3.3.1.2. All life safety items are completed and in working order.

- 20.3.3.1.3. Mechanical and electrical Work are complete and tested, fixtures are in place, connected, and ready for tryout.
- 20.3.3.1.4. Electrical circuits scheduled in panels and disconnect switches labeled.
- 20.3.3.1.5. Painting and special finishes complete.
- 20.3.3.1.6. Doors complete with hardware, cleaned of protective film, relieved of sticking or binding, and in working order.
- 20.3.3.1.7. Tops and bottoms of doors sealed.
- 20.3.3.1.8. Floors waxed and polished as specified.
- 20.3.3.1.9. Broken glass replaced and glass cleaned.
- 20.3.3.1.10. Grounds cleared of Contractor's equipment, raked clean of debris, and trash removed from Site.
- 20.3.3.1.11. Work cleaned, free of stains, scratches, and other foreign matter, of damaged and broken material replaced.
- 20.3.3.1.12. Finished and decorative work shall have marks, dirt, and superfluous labels removed.
- 20.3.3.1.13. Final cleanup, as provided herein.

20.4. Costs of Multiple Inspections

More than two (2) requests of the District to make a final inspection shall be considered an additional service of District, Architect, Construction Manager, and/or Project Inspector, and all subsequent costs will be invoiced to Contractor and if funds are available, withheld from remaining payments.

20.5. Partial Occupancy or Use Prior to Completion

20.5.1. District's Rights to Occupancy. The District may occupy or use any completed or partially completed portion of the Work at any stage. Neither the District's Final Acceptance, the making of Final Payment, any provision in Contract Documents, nor the use or occupancy of the Work, in whole or in part, by District shall constitute acceptance of Work not in accordance with the Contract Documents nor relieve the Contractor or the Contractor's Performance Bond Surety from liability with respect to any warranties or responsibility for faulty or defective Work or materials, equipment and workmanship incorporated therein. The District and the Contractor shall agree in writing to the responsibilities assigned to each of them for payments, security, maintenance, heat, utilities, damage to the Work, insurance, the period for correction of the Work, and the commencement of warranties required by the Contract Documents. Any dispute as to responsibilities shall be resolved pursuant to the Claims and Disputes provisions herein, with the added provision that during the dispute process, the District shall have the right to occupy or use any portion of the Work that it needs or desires to use.

20.5.2. Inspection Prior to Occupancy or Use. Immediately prior to partial occupancy or use, the District, the Contractor, and the Architect shall jointly inspect the area to be occupied or portion of the Work to be used in order to determine and record the condition of the Work.

20.5.3. No Waiver. Unless otherwise agreed upon, partial or entire occupancy or use of a portion or portions of the Work shall not constitute beneficial occupancy or acceptance of the Work not complying with the requirements of the Contract Documents.

21. FINAL PAYMENT AND RETENTION

21.1. Final Payment

21.1.1. Upon receipt and approval of a valid and final Application for Payment, the Architect will issue a final Certificate of Payment or similar document indicating Architect's agreement that the Project has reached Completion. The District shall thereupon jointly inspect the Work and either accept the Work as complete or notify the Architect and the Contractor in writing of reasons why the Work has not reached Completion to the satisfaction of the District.

21.1.2. Upon acceptance of the Work of the Contractor as having reached Completion to the satisfaction of the District (that, absent unusual circumstances, will occur when the Punch List items have been satisfactorily completed), the District may record a Notice of Completion with the County Recorder, and the Contractor shall, upon receipt of final payment from the District, pay all the amount(s) due to its Subcontractors.

21.2. Prerequisites for Final Payment

The following conditions must be fulfilled prior to Final Payment:

21.2.1. A full and final waiver or release of all stop notices and stop payment notices in connection with the Work shall be submitted by Contractor, including a release of stop notice or stop payment notice in recordable form, together with (to the extent permitted by law) a copy of the full and final release of all stop notice or stop payment notice rights.

21.2.2. A duly completed and executed conditional waiver and release upon final payment compliant with Civil Code section 8136 from each subcontractor of any tier and supplier to be paid from the current progress payment;

21.2.3. A duly completed and executed unconditional waiver and release upon final payment compliant with Civil Code section 8138 from each subcontractor of any tier and supplier that was paid from the previous progress payment; and

21.2.4. Contractor shall have made all corrections to the Work that are required to remedy any defects therein, to obtain compliance with the Contract Documents or any requirements of applicable codes and ordinances, or to fulfill any of the orders or directions of District required under the Contract Documents.

21.2.5. Each Subcontractor shall have delivered to the Contractor all written guarantees, warranties, applications, and bonds required by the Contract Documents for its portion of the Work.

21.2.6. Contractor must have completed all requirements set forth under "Closeout Procedures," including, without limitation, submission of an approved set of complete Record Drawings.

21.2.7. Architect shall have issued its written approval that final payment can be made.

21.2.8. Contractor shall have delivered to the District all manuals and materials required by the Contract Documents.

21.2.9. Contractor shall have completed final clean up as provided herein.

21.3. Retention

21.3.1. The retention, less any amounts disputed by the District or that the District has the right to withhold pursuant to provisions herein, shall be paid:

21.3.1.1. After approval of the District by the Architect's Certificate of Payment;

21.3.1.2. After the satisfaction of the conditions set forth herein;

21.3.1.3. Within sixty (60) days after Completion;

21.3.1.4. No earlier than thirty-five (35) days of the recording of the Notice of Completion by District, if a Notice of Completion is recorded by the District.

21.3.2. No interest shall be paid on any retention, or on any amounts withheld due to a failure of the Contractor to perform, in accordance with the terms and conditions of the Contract Documents, except as provided to the contrary in any Escrow Agreement between the District and the Contractor pursuant to Public Contract Code section 22300.

21.4. Substitution of Securities

The District will permit the substitution of securities in accordance with the provisions of Public Contract Code section 22300.

22. UNCOVERING OF WORK

If a portion of the Work is covered without Inspector or Architect approval or not in compliance with the Contract Documents, it must, if required in writing by the District, the Project Inspector, or the Architect, be uncovered for the Project Inspector's or the Architect's observation and be replaced at the Contractor's expense without change in the Contract Price or Contract Time.

23. NONCONFORMING WORK AND CORRECTION OF WORK

23.1. Nonconforming Work

23.1.1. Contractor shall promptly remove from Premises all Work identified by District as failing to conform to the Contract Documents whether incorporated or not. Contractor shall promptly replace and re-execute its own Work to comply with the Contract Documents without additional expense to the District and shall bear the expense of making good all work of other contractors destroyed or damaged by any removal or replacement pursuant hereto and/or any delays to the District or other Contractors caused thereby.

23.1.2. If Contractor does not remove Work that District has identified as failing to conform to the Contract Documents within a reasonable time, not to exceed **FORTY-EIGHT (48)** hours, District may remove it and may store any material at Contractor's expense. If Contractor does not pay expense(s) of that removal within ten (10) days' time thereafter, District may, upon ten (10) days' written notice, sell any material at auction or at private sale and shall deduct all costs and expenses incurred by the District and/or District may withhold those amounts from payment(s) to Contractor.

23.2. Correction of Work

23.2.1. Correction of Rejected Work. Pursuant to the notice provisions herein, the Contractor shall promptly correct the Work rejected by the District, the Architect, or the Project Inspector as failing to conform to the requirements of the Contract Documents, whether observed before or after Completion and whether or not fabricated, installed, or completed. The Contractor shall bear costs of correcting the rejected Work, including additional testing, inspections, and compensation for the Inspector's or the Architect's services and expenses made necessary thereby.

23.2.2. One-Year Warranty Corrections. If, within one (1) year after the date of Completion of the Work or a designated portion thereof, or after the date for commencement of warranties established hereunder, or by the terms of an applicable special warranty required by the Contract Documents, any of the Work is found to be not in accordance with the requirements of the Contract Documents, the Contractor shall correct it promptly after receipt of written notice from the District to do so. This period of one (1) year

shall be extended with respect to portions of the Work first performed after Completion by the period of time between Completion and the actual performance of the Work. This obligation hereunder shall survive acceptance of the Work under the Contract and termination of the Contract. The District shall give such notice promptly after discovery of the condition.

23.3. District's Right to Perform Work

23.3.1. If the Contractor should neglect to prosecute the Work properly or fail to perform any provisions of this Contract, the District, after **FORTY-EIGHT (48)** hours written notice to the Contractor, may, without prejudice to any other remedy it may have, make good such deficiencies and may deduct the cost thereof from the payment then or thereafter due the Contractor.

23.3.2. If it is found at any time, before or after Completion of the Work, that Contractor has varied from the Drawings and/or Specifications, including, but not limited to, variation in material, quality, form, or finish, or in the amount or value of the materials and labor used, District may require at its option:

23.3.2.1. That all such improper Work be removed, remade or replaced, and all work disturbed by these changes be made good by Contractor at no additional cost to the District;

23.3.2.2. That the District deduct from any amount due Contractor the sum of money equivalent to the difference in value between the work performed and that called for by the Drawings and Specifications; or

23.3.2.3. That the District exercise any other remedy it may have at law or under the Contract Documents, including but not limited to the District hiring its own forces or another contractor to replace the Contractor's nonconforming Work, in which case the District shall either issue a deductive Change Order, a Construction Change Directive, or invoice the Contractor for the cost of that work. Contractor shall pay any invoices within thirty (30) days of receipt of same or District may withhold those amounts from payment(s) to Contractor.

24. TERMINATION AND SUSPENSION

24.1. District's Right to Terminate Contractor for Cause

24.1.1. Grounds for Termination. The District, in its sole discretion, may terminate the Contract and/or terminate the Contractor's right to perform the work of the Contract based upon the following:

24.1.1.1. Contractor refuses or fails to execute the Work or any separable part thereof with sufficient diligence as will ensure its completion within the time specified or any extension thereof, or

24.1.1.2. Contractor fails to complete said Work within the time specified or any extension thereof, or

24.1.1.3. Contractor persistently fails or refused to perform Work or provide material of sufficient quality as to be in compliance with Contract Documents; or

24.1.1.4. Contractor files a petition for relief as a debtor, or a petition is filed against the Contractor without its consent, and the petition not dismissed within sixty (60) days; or

24.1.1.5. Contractor makes a general assignment for the benefit of its creditors, or a receiver is appointed on account of its insolvency; or

24.1.1.6. Contractor persistently or repeatedly refuses fails, except in cases for which extension of time is provided, to supply enough properly skilled workers or proper materials to complete the Work in the time specified; or

24.1.1.7. Contractor fails to make prompt payment to Subcontractors, or for material, or for labor; or

24.1.1.8. Contractor persistently disregards laws, or ordinances, or instructions of District; or

24.1.1.9. Contractor fails to supply labor, including that of Subcontractors, that can work in harmony with all other elements of labor employed or to be employed on the Work; or

24.1.1.10. Contractor or its Subcontractor(s) is/are otherwise in breach, default, or in substantial violation of any provision of this Contract.

24.1.2. Notification of Termination

24.1.2.1. Upon the occurrence at District's sole determination of any of the above conditions, District may, without prejudice to any other right or remedy, serve written notice upon Contractor and its Surety of District's termination of this Contract and/or the Contractor's right to perform the work of the Contract. This notice will contain the reasons for termination. Unless, within three (3) days after the service of the notice, any and all condition(s) shall cease, and any and all violation(s) shall cease, or arrangement satisfactory to District for the correction of the condition(s) and/or violation(s) be made, this Contract and/or the Contractor's right to perform the Work shall cease and terminate. Upon termination, Contractor shall not be entitled to receive any further payment until the entire Work is finished.

24.1.2.2. Upon termination, District may immediately serve written notice of tender upon Surety whereby Surety shall have the right to take over and perform this Contract only if Surety:

24.1.2.2.1. Within three (3) days after service upon it of the notice of tender, gives District written notice of Surety's intention to take over and perform this Contract; and

24.1.2.2.2. Commences performance of the Contract within three (3) days from date of serving of its notice to District.

24.1.2.3. If Surety fails to notify District or begin performance as indicated herein, District may take over the Work and execute the Work to completion by any method it may deem advisable at the expense of Contractor and/or its Surety. Contractor and/or its Surety shall be liable to District for any excess cost or other damages the District incurs thereby. Time is of the essence in the Contract. If the District takes over the Work as herein provided, District may, without liability for so doing, take possession of and utilize in completing the Work such materials, appliances, plan, and other property belonging to Contractor as may be on the Site of the Work, in bonded storage, or previously paid for.

24.1.3. Effect of Termination

24.1.3.1. Contractor shall, only if ordered to do so by the District, immediately remove from the Site all or any materials and personal property belonging to Contractor that have not been incorporated in the construction of the Work, or which are not in place in the Work. District retains the right, but not the obligation, to keep and use any materials and personal property belonging to Contractor that have not been incorporated in the construction of the Work, or which are not in place in the Work. Contractor and its Surety shall be liable upon the performance bond for all damages caused the District by reason of the Contractor's failure to complete the Contract.

24.1.3.2. In the event that the District shall perform any portion of, or the whole of the Work, pursuant to the provisions of the General Conditions, the District shall not be liable nor account to the Contractor in any way for the time within which, or the manner in which, the Work is performed by the District or for any changes the District may make in the Work or for the money expended by the District in satisfying claims and/or suits and/or other obligations in connection with the Work.

24.1.3.3. In the event that the Contract is terminated for any reason, no allowances or compensation will be granted for the loss of any anticipated profit by the Contractor or any impact or impairment of Contractor's bonding capacity.

24.1.3.4. If the expense to the District to finish the Work exceeds the unpaid Contract Price, Contractor and Surety shall pay difference to District within twenty-one (21) days of District's request.

24.1.3.5. District shall have the right (but shall have no obligation) to assume and/or assign to a general contractor or construction manager or other third party who is qualified and has sufficient resources to complete the Work, the rights of the Contractor under its subcontracts with any or all Subcontractors. In the event of an assumption or assignment by the District, no Subcontractor shall have any claim against the District or third party for Work performed by Subcontractor or other matters arising prior to termination of the Contract. The District or any third party, as the case may be, shall be liable only for obligations to the Subcontractor arising after assumption or assignment. Should the District so elect, the Contractor shall execute and deliver all documents and take all steps, including the legal assignment of its contractual rights, as the District may require, for the purpose of fully vesting in the District the rights and benefits of it Subcontractor under Subcontracts or other obligations or commitments. All payments due the Contractor hereunder shall be subject to a right of offset by the District for expenses and damages suffered by the District as a result of any default, acts, or omissions of the Contractor. Contractor must include this assignment provision in all of its contracts with its Subcontractors.

24.1.3.6. The foregoing provisions are in addition to and not in limitation of any other rights or remedies available to District.

24.2. Emergency Termination of Public Contracts Act of 1949

24.2.1. The Contract is subject to termination as provided by sections 4410 and 4411 of the Government Code of the State of California, being a portion of the Emergency Termination of Public Contracts Act of 1949.

24.2.1.1. Section 4410 of the Government Code states:

In the event a national emergency occurs, and public work, being performed by contract, is stopped, directly or indirectly, because of the freezing or diversion of materials, equipment or labor, as the result of an order or a proclamation of the President of the United States, or of an order of any federal authority, and the circumstances or conditions are such that it is impracticable within a reasonable time to proceed with a substantial portion of the work, then the public agency and the contractor may, by written agreement, terminate said contract.

24.2.1.2. Section 4411 of the Government Code states:

Such an agreement shall include the terms and conditions of the termination of the contract and provision for the payment of compensation or money, if any, which either party shall pay to the other or any other person, under the facts and circumstances in the case.

24.2.2. Compensation to the Contractor shall be determined at the sole discretion of District on the basis of the reasonable value of the Work done, including preparatory work. As an exception to the foregoing and at the District's discretion, in the case of any fully completed separate item or portion of the Work for which there is a separate previously submitted unit price or item on the accepted Schedule of Values, that price shall control. District, in its sole discretion, may adopt the Contract Price as the reasonable value of the Work performed or any portion thereof.

24.3. Termination of Contractor for Convenience

24.3.1. District in its sole discretion may terminate the Contract upon three (3) days written notice to the Contractor. Under a termination for convenience, the District retains the right to all the options available to the District if there is a termination for cause. In case of a termination for convenience, Contractor shall have no claims against the District except:

24.3.1.1. The actual cost for labor, materials, and services performed that is unpaid and can be documented through timesheets, invoices, receipts, or otherwise, and

24.3.1.2. Five percent (5%) of the total cost of work performed as of the date of termination, or five percent (5%) of the value of the Work yet to be performed, whichever is less. This five percent (5%) amount shall be full compensation for all Contractor's and its Subcontractor(s)' mobilization and/or demobilization costs and any anticipated loss profits resulting from termination of the Contractor for convenience.

24.4. Suspension of Work

24.4.1. District may, without cause, order Contractor in writing to suspend, delay or interrupt the Project in whole or in part for such period of time as District may determine. When the District resumes the Project, the Parties will attempt to negotiate an adjustment in the Contract Price for increases or decreases in the cost of performance of the Project caused by suspense, delay or interruption. If the parties cannot agree on an adjusted Contract Price, the District may terminate the Contract as permitted herein.

24.4.2. In the event that the District exercises this option, the District shall pay for any and all Work and materials completed or delivered onto the Site for which value is received, and the value of any and all Work then in progress and orders actually placed which cannot be canceled up to the date of notice of termination. The value of work and materials paid for shall include a factor of six percent (6%) for the Contractor's overhead and profit and there shall be no other costs or expenses paid to Contractor. All work, materials and orders paid for pursuant to this provision shall become the property of the District.

24.5. Scope Reduction

In cases of suspension, partial or complete termination, or at the discretion of the District, the District reserves the right to unilaterally approve a deductive Change Order to reduce scope of work or perform work with other forces or its own forces.

25. DISPUTES AND CLAIMS

25.1. Performance during Dispute and Claim Resolution Process.

The Contractor shall diligently proceed with Work on the Project at the same time that Disputes and Claims are addressed under this Article. It is the intent of District to resolve Disputes with the Contractor as close to the events giving rise to the Disputes as possible, and to avoid stale or late Claims and the late documenting of Claims. Contractor's failure to diligently proceed in accordance with the District's instructions or the Contract terms will be considered a material breach of this Agreement and a waiver of Contractor's rights under this Agreement.

25.2. Waiver.

If Contractor fails to timely submit any written notices required under the terms of the Contract or in this Disputes and Claims section, Contractor waives and releases its rights regarding further review of its Dispute or Claim, unless Contractor and District mutually agree in writing to other time limits.

25.3. Intention.

The Dispute and Claims Resolution Process required herein are intended to provide a concise mechanism for resolving Disputes and Claims as they arise during the Project, while requiring accurate documentation related to contested issues as to those Disputes and Claims that are not contemporaneously resolved.

25.4. Exclusive Remedy.

Compliance with the notice provisions of the Contract as well as the claim submission procedures described in this Disputes and Claims section is an express condition precedent to Contractor's right to commence litigation, file a claim under the California Government Code, or commence any other legal action. The Contractor cannot bring assert or bring any Claim in any Government Code claim or subsequent legal action until that Claim has gone through the Dispute and Claims Resolution Process herein. The District hereby exercises the power conferred upon it by Government Code Sections 930.2 and 930.4 to augment claims presentation procedures and create its own Dispute and Claims Resolution Process as an exclusive remedy as indicated in this Disputes and Claims section.

25.5. Other Provisions.

If portions of the Contract, other than this Disputes and Claims section establish a specific process regarding a specific subject, then that process shall govern and control the resolutions of any disagreements thereunder. Otherwise, the provisions in this Disputes and Claims section shall control the resolution of all Disputes and Claims.

25.6. Subcontractors.

Contractor is responsible for providing this Disputes and Claims section to its Subcontractors and for ensuring that all Subcontractors or others who may assert Claims by and through Subcontractors and/or the Contractor are informed of the Dispute and Claims resolution process in this Disputes and Claims section. No Claim submitted by any party that fails to follow the provisions of this Disputes and Claims section will be considered. Contractor shall indemnify, keep and hold harmless the District and its consultants, against all suits, claims, damages, losses, and expenses, including but not limited to attorney's fees, caused by, arising out of, resulting from, or incidental to, the failure to provide this Disputes and Claims section to its Subcontractors or others who may assert Claims by and through Subcontractors and/or the Contractor.

25.7. Dispute and Claim Resolution Process

25.7.1. Dispute: A Dispute is a written demand by Contractor or by Subcontractor(s) or others who make a demand or request by and through Contractor during performance of the Work for an adjustment of the Contract Time, Contract Price, interpretation of the Contract Documents, or other relief with respect to the Contract Documents for which Contractor has previously provided written notice to the District pursuant to the terms of the Contract which remain unresolved. A PCO may be a Dispute, but the Parties agree that a PCO shall only be a Dispute if:

25.7.1.1. The District states in writing that it disagrees with the terms of a PCO and directs the Contractor to utilize the Dispute Resolution Process, or

25.7.1.2. The District rejects in whole or in part a PCO and the Contractor states in writing that it is utilizing the Dispute Resolution Process for the portion of the PCO that the District rejected.

25.7.2. Claim: A Claim is a Dispute that remains unresolved after conclusion of the Dispute Resolution Process identified below. Individual unresolved Disputes may be aggregated into one or more Claim(s).

25.7.3. Dispute Resolution Process (Not for Claims)

25.7.3.1. Identifying, Presenting and Documenting a Dispute

25.7.3.1.1. Every Dispute shall be stated with specificity in writing and signed by Contractor under penalty of perjury and presented to the District within ten (10) calendar days from the date Contractor discovers or reasonably should discover, that an act, error or omission of District, its agents or employees, or action, condition or other situation has occurred that may entitle Contractor to an adjustment of the Contract Price and/or Contract Time. Contractor shall provide this writing even if Contractor has not yet been damaged, delayed, or incurred extra cost when

Contractor discovers, or reasonably should discover, the act, error, omission, action, condition or situation giving rise to the incidents giving rise to the Dispute. The writing shall:

25.7.3.1.1.1. Identify all of the issues, events, conditions, circumstances and/or causes giving rise to the Dispute;

25.7.3.1.1.2. Identify all pertinent dates and/or durations and all actual and/or anticipated effects on the Contract Price, milestones and/or Contract Time adjustments; and

25.7.3.1.1.3. Identify in detail line-item costs if the Dispute seeks money.

25.7.3.1.1.4. If the Dispute involves extra work, a detailed cost breakdown of the amounts the Contractor is seeking, including actual cost records (including without limitation, payroll records, material and rental invoices and the like) demonstrating that those costs have actually been incurred. To the extent costs have not yet been incurred at the time the Dispute is submitted, actual cost records must be submitted on a current basis not less than once a week during any periods costs are incurred. A cost record will be considered current if submitted within seven (7) days of the date the cost reflected in the record is incurred. At the request of District, extra costs may be subject to further verification procedures (such as having an inspector verify the performance of alleged extra work on a daily basis).

25.7.3.1.1.5. If the Dispute involves an error or omission in the Contract Documents:

25.7.3.1.1.5.1. An affirmative representation under penalty of perjury by Contractor and any affected Subcontractors and suppliers that the error or omission was not discovered prior to submitting a proposal for the Work, and

25.7.3.1.1.5.2. A detailed statement demonstrating that the error or omission reasonably should not have been discovered, by Contractor, its Subcontractors and suppliers, prior to submitting a proposal for the Work.

25.7.3.1.1.6. Contractor shall not be entitled to compensation for escalation of materials costs unless Contractor demonstrates to the satisfaction of the District that such cost escalation is the result of unusual, unforeseeable market conditions, not the fault of the Contractor, and were not reasonably foreseeable at the time of the award of the Contract. Contractor shall provide evidence to District of the costs included in the Contract for those materials and that those costs were reasonable at the time and that Contractor timely ordered the materials at issue.

25.7.3.1.2. The writing shall be accompanied by all documents substantiating Contractor's position regarding the Dispute. A Dispute that asserts an effect on any schedule milestones and/or Contract Time shall include all pertinent scheduling data demonstrating the impact(s) on the critical path(s), milestone(s) and/or Contract Time.

25.7.3.1.3. Contractor acknowledges that its failure, for any reason, to give written notice (with supporting documentation to permit the District's review and evaluation) within the time frame required by the provisions in this Disputes and Claims section, or its actual or constructive knowledge of any instruction, request, Drawings, Specifications, action, condition, omission, default or other situation for which the Contractor believes there should an adjustment of the Contract Price or Contract Time shall be deemed Contractor's waiver, release, discharge and relinquishment of any right to assert, request, or demand any entitlement to an adjustment of the Contract Time or the Contract Price on account of any such instruction, request, Drawings, Specifications, action, condition, omission, default or other situation. Contractor further acknowledged that strict compliance with the requirements of the provisions in this Disputes and Claims section is an express condition precedent to Contractor's right to arbitrate or litigate a

claim. Contractor specifically agrees to assert no demands or claims in arbitration or litigation unless there has been strict compliance with the provisions in this Disputes and Claims section.

25.7.3.1.4. Architect's and/or Construction Manager's ("AE/CM") Initial Decision. The District's AE/CM shall issue a written decision regarding the Dispute to the Contractor within ten (10) calendar days of receipt of the written Dispute from the Contractor.

25.7.3.2. Meet and Confer

25.7.3.2.1. Where There Is No Agreement: If there is no agreement between Contractor and the AE/CM on a Contractor's Dispute, then within ten (10) calendar days of the date of the District's written decision in response to Contractor's Dispute or PCO, Contractor shall give written notice of its demand for a meet and confer meeting with District staff. A meet and confer meeting with District staff shall be a condition precedent to Contractor seeking any further relief, including a demand for review as indicated below, in connection with the District's rejection.

25.7.3.2.2. Where There Is Partial Agreement: If Contractor and the AE/CM partially agree on a Contractor's Dispute but do not reach complete agreement, then the AE/CM shall issue a written decision or prepare a Change Order, if applicable, for the issues and/or amounts agreed to. For those issues not agreed to, Contractor shall give written notice of its demand for a meet and confer meeting with District staff. A meet and confer meeting with District staff shall be a condition precedent to Contractor seeking any further relief, including a demand for review as indicated below, in connection with the District's rejection.

25.7.3.2.3. District and Contractor shall schedule the meet and confer meeting as soon as reasonably possible after Contractor's written notice of its demand for a meet and confer meeting.

25.7.3.3. Contractor's Demand for Review of Dispute

25.7.3.3.1. Contractor shall submit a written demand for review to the District with copy to the AE/CM, within ten (10) calendar days of the meet and confer meeting. The written demand for review shall include copies of all documentation the Contractor intends to rely upon in substantiating Contractor's position regarding the Dispute, including any supplementary documentation the Contractor deems appropriate for the District's consideration.

25.7.3.3.1.1. District's Written Decision. The District will review the Dispute and issue a written decision to Contractor within thirty (30) calendar days from the date the demand for review and supporting documentation are received by the District. The District has the option to meet with Contractor, or with Contractor and any other party, before issuing a decision.

25.7.3.3.1.2. If no decision is issued within thirty (30) days after the demand for review, the District will be deemed to have rejected Contractor's Dispute in its entirety, and Contractor shall proceed with the Claim Resolution Process below.

25.7.3.3.1.3. If the District's decision completely resolves the Dispute, the District will prepare and process a Change Order, if applicable, or proceed accordingly.

25.7.3.3.1.4. If the District rejects the Contractor's Dispute in whole or in part or does not issue a timely written response, and if Contractor ever intends to seek relief regarding the unresolved issues of the Dispute, then Contractor shall proceed with the Claim Resolution Process below.

25.7.3.3.1.5. Contractor's costs incurred in seeking relief for Disputes and Claims are not recoverable from District.

25.7.4. Claim Resolution Process.

25.7.4.1. If Contractor's Dispute has not been resolved during the Dispute Resolution Process, the Contractor shall submit within thirty (30) days of the District's written decision, a Claim with the required documentation set forth below for District's consideration.

25.7.4.2. Contractor shall furnish three (3) certified copies of the required Claim documentation. The Claim documentation shall be complete when furnished. The evaluation of Contractor's Claim will be based on District records and the Claim document furnished by Contractor.

25.7.4.3. Contractor's Claim documentation shall conform to generally accepted accounting principles and shall be in the following format:

25.7.4.3.1. General Introduction

25.7.4.3.2. General Background Discussion

25.7.4.3.3. Index of Issues (listed numerically)

25.7.4.3.4. For each issue, provide the following information and begin each issue on a new page:

25.7.4.3.4.1. Background

25.7.4.3.4.2. Chronology

25.7.4.3.4.3. Contractor's position including all reason(s) for District's potential liability

25.7.4.3.4.4. Supporting documentation of merit or entitlement

25.7.4.3.4.5. Supporting documentation of damages

25.7.4.3.5. All critical path method schedules, both as-planned, monthly updates, schedule revisions, and as-build along with the computer disks of all schedules related to the Claim.

25.7.4.3.6. Productivity exhibits (if appropriate)

25.7.4.3.7. Summary of Damages for each issue

25.7.4.4. Supporting documentation of merit or entitlement for each issue shall be cited by reference, photocopies, or explanation. Supporting documentation may include, but shall not be limited to the Contract Documents; correspondence; conference notes; shop drawings and submittals; shop drawing logs; survey books; inspection reports; delivery schedules; test reports; daily reports; subcontracts; fragmentary CPM schedules or time impact analyses; photographs; technical reports; requests for information; field instructions; and all other related records necessary to support the Contractor's Claim.

25.7.4.5. Supporting documentation of damages for each issue shall be cited, photocopied, or explained. Supporting documentation may include, but shall not be limited to, any or all documents related to the preparation and submission of the proposal; certified, detailed labor records, including labor distribution reports; material and equipment procurement records; construction equipment ownership costs records or rental records; job cost reports; Subcontractor or vendor files and cost records; service cost records; purchase orders; invoices; Project as-planned and as-built cost records; general ledger records; variance reports; accounting adjustment records; and any other accounting materials necessary to support the Contractor's Claim.

25.7.4.6. Contractor shall include in its Claim documents all issue items and information that Contractor contends are part of its Claim. Issues not included in the Claim documents shall not be considered.

25.7.4.7. Each copy of the Claim documentation shall be certified by a responsible officer of the Contractor in accordance with the requirements of the Contract Documents.

25.7.4.8. The District may withhold from a progress payment and/or the final payment an amount not to exceed 150 percent of the disputed amount. The District may, but is not obligated to, notify the Surety and request the Surety's assistance in resolving the controversy.

25.7.4.9. **District's Written Decision.** The District will render a written decision to the Contractor relative to the Claim. The District's written decision shall be final and binding on the party(ies), unless Contractor requests mediation pursuant to this subsection.

25.7.4.10. Mediation.

25.7.4.10.1. Within thirty (30) days after the District renders its written decision, the Contractor may request that the parties submit the Claim to mediation. This mediation is a mandatory step if the Contractor decides to pursue its Claim.

25.7.4.10.2. At the District's sole discretion, this mediation may be a multiple-party mediation with the Architect, the Construction Manager, the Inspector, and/or other District consultants.

25.7.4.10.3. Absent a request for mediation, the District's written decision is final and binding on the parties.

25.7.4.11. **Litigation.** If, after a mediation as indicated above, the parties have not resolved the Claim, the receiving party's decision made pursuant to mediation will be conclusive and binding regarding the Dispute unless the submitting party commences an action in a court of competent jurisdiction to contest such decision within ninety (90) days following the conclusion of such mediation or one (1) year following the accrual of the cause of action, whichever is later.

25.7.5. The District shall be entitled to remedy any false claims, as defined in California Government Code section 12650 *et seq.*, made to the District by the Contractor or any Subcontractor under the standards set forth in Government Code section 12650 *et seq.* Any Contractor or Subcontractor who submits a false claim shall be liable to the District for three times the amount of damages that the District sustains because of the false claim. A Contractor or Subcontractor who submits a false claim shall also be liable to the District for (a) the costs, including attorney fees, of a civil action brought to recover any of those penalties or damages, and (b) a civil penalty of up to \$11,000 for each false claim.

25.8. Documentation of Resolution.

If a Claim is resolved, the District shall determine if that resolution shall be documented in an Agreement and Release of Any and All Claims form or other document, as appropriate.

25.9. Dispute and Claim Resolution Process – Non-Applicability.

The procedures and provisions in this Disputes and Claims section shall not apply to:

25.9.1. District's determination of what Work is or will be constructed, or whether the Work complies with the Contract Documents for purposes of accepting the Work;

25.9.2. District's rights and obligations as a public entity, such as, but without limitation, the revocation of pre-qualified or qualified status, barring a contractor from District contracts, the imposition of penalties or forfeitures prescribed by statute or regulation; provided, however, that penalties imposed against a public

entity by statutes such as Section 7107 of the Public Contract Code, shall be subject to the mandatory dispute resolution provisions of this Disputes and Claims section and the Contract;

25.9.3. Personal injury, wrongful death or property damage claims;

25.9.4. Latent defect or breach of warranty or guarantee to repair;

25.9.5. Stop notices or stop payment notices; or

25.9.6. Any other District rights as set forth herein.

26. LABOR, WAGE & HOUR, APPRENTICE AND RELATED PROVISIONS

26.1. Contractor & Subcontractor Registration

26.1.1. Contractor shall comply with the registration and compliance monitoring provisions of Labor Code section 1771.4, including furnishing its CPRs to the Labor Commissioner of California and complying with any applicable enforcement by the Department of Industrial Relations. Labor Code section 1771.1(a) states the following:

“A contractor or subcontractor shall not be qualified to bid on, be listed in a bid proposal, subject to the requirements of Section 4104 of the Public Contract Code, or engage in the performance of any contract for public work, as defined in this chapter, unless currently registered and qualified to perform public work pursuant to Section 1725.5. It is not a violation of this section for an unregistered contractor to submit a bid that is authorized by Section 7029.1 of the Business and Professions Code or by Section 10164 or 20103.5 of the Public Contract Code, provided the contractor is registered to perform public work pursuant to Section 1725.5 at the time the contract is awarded.”

26.1.2. Contractor acknowledges that, for purposes of Labor Code section 1725.5, all or some of the Work is a public work to which Labor Code section 1771 applies. Contractor shall comply with Labor Code section 1725.5, including without limitation the registration requirements. Additionally, all Contractor's Subcontractors shall comply with Labor Code section 1725.5 to be qualified to bid on, be listed in a bid proposal, subject to the requirements of Section 4104 of the Public Contract Code, or engage in the performance of the Contract. Contractor represents that all of its Subcontractors are registered pursuant to Labor Code section 1725.5.

26.1.3. The Project is subject to compliance monitoring and enforcement by the Department of Industrial Relations. Contractor shall post job site notices, as prescribed by regulation. Contractor shall comply with all requirements of Labor Code section 1771.4, except the requirements that are exempted by the Labor Commissioner for the Project.

26.2. Wage Rates, Travel and Subsistence

26.2.1. Pursuant to the provisions of article 2 (commencing at section 1770), chapter 1, part 7, division 2, of the Labor Code of California, the general prevailing rate of per diem wages and the general prevailing rate for holiday and overtime work in the locality in which this public work is to be performed for each craft, classification, or type of worker needed to execute this Contract are on file at the District's principal office and copies will be made available to any interested party on request. Contractor shall obtain and post a copy of these wage rates at the job site.

26.2.2. Holiday and overtime work, when permitted by law, shall be paid for at a rate of at least one and one-half times the above specified rate of per diem wages, unless otherwise specified. The holidays upon which those rates shall be paid need not be specified by the District, but shall be all holidays recognized in the applicable collective bargaining agreement. If the prevailing rate is not based on a collectively

bargained rate, the holidays upon which the prevailing rate shall be paid shall be as provided in Section 6700 of the Government Code.

26.2.3. Contractor shall pay and shall cause to be paid each worker engaged in Work on the Project not less than the general prevailing rate of per diem wages determined by the Director of the Department of Industrial Relations ("DIR") ("Director"), regardless of any contractual relationship which may be alleged to exist between Contractor or any Subcontractor and such workers.

26.2.4. If during the period this bid is required to remain open, the Director determines that there has been a change in any prevailing rate of per diem wages in the locality in which the Work under the Contract is to be performed, such change shall not alter the wage rates in the Notice to Bidders or the Contract subsequently awarded.

26.2.5. Pursuant to Labor Code section 1775, Contractor shall, as a penalty to District, forfeit the statutory amount, (currently not to exceed two hundred dollars (\$200) for each calendar day, or portion thereof), for each worker paid less than the prevailing rates, as determined by the District and/or the Director, for the work or craft in which that worker is employed for any public work done under Contract by Contractor or by any Subcontractor under it.

26.2.5.1. The amount of the penalty shall not be less than forty dollars (\$40) for each calendar day, or portion thereof, unless the failure of Contractor was a good faith mistake and, if so, the error was promptly and voluntarily corrected when brought to the attention of Contractor.

26.2.5.2. The amount of the penalty shall not be less than eighty dollars (\$80) for each calendar day or portion thereof, if Contractor has been assessed penalties within the previous three (3) years for failing to meet Contractor's prevailing wage obligations on a separate contract, unless those penalties were subsequently withdrawn or overturned.

26.2.5.3. The amount of the penalty may not be less than one hundred twenty dollars (\$120) for each calendar day, or portion thereof, if the Labor Commissioner determines the Contractor willfully violated Labor Code section 1775.

26.2.5.4. The difference between such prevailing wage rates and the amount paid to each worker for each calendar day or portion thereof for which each worker was paid less than the prevailing wage rate, shall be paid to each worker by Contractor.

26.2.6. Any worker employed to perform Work on the Project, which Work is not covered by any classification listed in the general prevailing wage rate of per diem wages determined by the Director, shall be paid not less than the minimum rate of wages specified therein for the classification which most nearly corresponds to Work to be performed by him, and such minimum wage rate shall be retroactive to time of initial employment of such person in such classification.

26.2.7. Pursuant to Labor Code section 1773.1, per diem wages are deemed to include employer payments for health and welfare, pension, vacation, travel time, subsistence pay, and apprenticeship or other training programs authorized by section 3093, and similar purposes.

26.2.8. Contractor shall post at appropriate conspicuous points on the Site of Project, a schedule showing all determined minimum wage rates and all authorized deductions, if any, from unpaid wages actually earned. In addition, Contractor shall post a sign-in log for all workers and visitors to the Site, a list of all subcontractors of any tier on the Site, and the required Equal Employment Opportunity poster(s).

26.3. Hours of Work

26.3.1. As provided in article 3 (commencing at section 1810), chapter 1, part 7, division 2, of the Labor Code, eight (8) hours of labor shall constitute a legal days work. The time of service of any worker employed at any time by Contractor or by any Subcontractor on any subcontract under this Contract upon

the Work or upon any part of the Work contemplated by this Contract shall be limited and restricted by Contractor to eight (8) hours per day, and forty (40) hours during any one week, except as hereinafter provided. Notwithstanding the provisions hereinabove set forth, Work performed by employees of Contractor in excess of eight (8) hours per day and forty (40) hours during any one week, shall be permitted upon this public work upon compensation for all hours worked in excess of eight (8) hours per day at not less than one and one-half times the basic rate of pay.

26.3.2. Contractor shall keep and shall cause each Subcontractor to keep an accurate record showing the name of and actual hours worked each calendar day and each calendar week by each worker employed by Contractor in connection with the Work or any part of the Work contemplated by this Contract. The record shall be kept open at all reasonable hours to the inspection of District and to the Division of Labor Standards Enforcement of the DIR.

26.3.3. Pursuant to Labor Code section 1813, Contractor shall as a penalty to the District forfeit the statutory amount (believed by the District to be currently twenty five dollars (\$25)) for each worker employed in the execution of this Contract by Contractor or by any Subcontractor for each calendar day during which such worker is required or permitted to work more than eight (8) hours in any one calendar day and forty (40) hours in any one calendar week in violation of the provisions of article 3 (commencing at section 1810), chapter 1, part 7, division 2, of the Labor Code.

26.3.4. Any Work necessary to be performed after regular working hours, or on Sundays or other holidays shall be performed without additional expense to the District.

26.4. Payroll Records

26.4.1. If requested by the District, Contractor shall provide to the District and shall cause each Subcontractor performing any portion of the Work to provide the District and an accurate and certified payroll record ("CPR(s)"), showing the name, address, social security number, work classification, straight time, and overtime hours worked each day and week, and the actual per diem wages paid to each journeyman, apprentice, worker, or other employee employed by the Contractor and/or each Subcontractor in connection with the Work.

26.4.1.1. In addition to any other requirements pursuant to Labor Code sections 1770, et seq., the CPRs enumerated hereunder shall be certified and shall be provided to the District on a weekly basis. The CPRs from the Contractor and each Subcontractor for each week shall be provided on or before Wednesday of the week following the week covered by the CPRs. District shall not make any payment to Contractor until:

26.4.1.1.1. Contractor and/or its Subcontractor(s) provide CPRs acceptable to the District, and

26.4.1.1.2. The District is given sufficient time to review and/or audit the CPRs to determine their acceptability. Any delay in Contractor and/or its Subcontractor(s) providing CPRs to the District in a timely manner will directly delay the District's review and/or audit of the CPRs and Contractor's payment.

26.4.2. All CPRs shall be available for inspection at all reasonable hours at the principal office of Contractor on the following basis:

26.4.2.1. A certified copy of an employee's CPR shall be made available for inspection or furnished to the employee or his/her authorized representative on request.

26.4.2.2. CPRs shall be made available for inspection or furnished upon request to a representative of District, Division of Labor Standards Enforcement, Division of Apprenticeship Standards, and/or the Department of Industrial Relations.

26.4.2.3. CPRs shall be made available upon request by the public for inspection or copies thereof made; provided, however, that a request by the public shall be made through either the District, Division of Apprenticeship Standards, or the Division of Labor Standards Enforcement. If the requested CPRs have not been provided pursuant to the provisions herein, the requesting party shall, prior to being provided the records reimburse the costs of preparation by Contractor, Subcontractors, and the entity through which the request was made. The public shall not be given access to the records at the principal office of Contractor.

26.4.3. The form of certification for the CPRs shall be as follows:

I, _____ (Name-Print), the undersigned, am the _____ (Position in business) with the authority to act for and on behalf of _____ (Name of business and/or Contractor), certify under penalty of perjury that the records or copies thereof submitted and consisting of _____ (Description, number of pages) are the originals or true, full, and correct copies of the originals which depict the payroll record(s) of actual disbursements by way of cash, check, or whatever form to the individual or individual named, and (b) we have complied with the requirements of sections 1771, 1811, and 1815 of the Labor Code for any work performed by our employees on the Project.

Date: _____ Signature: _____
(Section 16401 of Title 8 of the California Code of Regulations)

26.4.4. Each Contractor shall file a certified copy of the CPRs with the entity that requested the records within ten (10) days after receipt of a written request.

26.4.5. Any copy of records made available for inspection as copies and furnished upon request to the public or any public agency by District, Division of Apprenticeship Standards, or Division of Labor Standards Enforcement shall be marked or obliterated in such a manner as to prevent disclosure of an individual's name, address, and social security number. The name and address of Contractor awarded Contract or performing Contract shall not be marked or obliterated.

26.4.6. Contractor shall inform District of the location of the records enumerated hereunder, including the street address, city, and county, and shall, within five (5) working days, provide a notice of change of location and address.

26.4.7. In the event of noncompliance with the requirements of this section, Contractor shall have ten (10) days in which to comply subsequent to receipt of written notice specifying in what respects Contractor must comply with this section. Should noncompliance still be evident after the ten (10) day period, Contractor shall, as a penalty to District, forfeit one hundred dollars (\$100) for each calendar day, or portion thereof, for each worker, until strict compliance is effectuated. Upon the request of Division of Apprenticeship Standards or Division of Labor Standards Enforcement, these penalties shall be withheld from progress payments then due.

26.4.8. It shall be the responsibility of Contractor to ensure compliance with the provisions of Labor Code section 1776.

26.5. Apprentices

26.5.1. Contractor acknowledges and agrees that, if this Contract involves a dollar amount greater than or a number of working days greater than that specified in Labor Code section 1777.5, then this Contract is governed by the provisions of Labor Code Section 1777.5. It shall be the responsibility of Contractor to ensure compliance with this Article and with Labor Code section 1777.5 for all apprenticeship occupations.

26.5.2. Apprentices of any crafts or trades may be employed and, when required by Labor Code section 1777.5, shall be employed provided they are properly registered in full compliance with the provisions of the Labor Code.

26.5.3. Every such apprentice shall be paid the standard wage paid to apprentices under the regulations of the craft or trade at which he/she is employed, and shall be employed only at the work of the craft or trade to which she/he is registered.

26.5.4. Only apprentices, as defined in section 3077 of the Labor Code, who are in training under apprenticeship standards and written apprentice agreements under chapter 4 (commencing at section 3070), division 3, of the Labor Code, are eligible to be employed. The employment and training of each apprentice shall be in accordance with the provisions of the apprenticeship standards and apprentice agreements under which he/she is training.

26.5.5. Pursuant to Labor Code section 1777.5, if that section applies to this Contract as indicated above, Contractor and any Subcontractors employing workers in any apprenticeable craft or trade in performing any Work under this Contract shall apply to the applicable joint apprenticeship committee for a certificate approving the Contractor or Subcontractor under the applicable apprenticeship standards and fixing the ratio of apprentices to journeymen employed in performing the Work.

26.5.6. Pursuant to Labor Code section 1777.5, if that section applies to this Contract as indicated above, Contractor and any Subcontractor may be required to make contributions to the apprenticeship program.

26.5.7. If Contractor or Subcontractor willfully fails to comply with Labor Code section 1777.5, then, upon a determination of noncompliance by the Administrator of Apprenticeship, it shall:

26.5.7.1. Be denied the right to bid on any subsequent project for one (1) year from the date of such determination;

26.5.7.2. Forfeit as a penalty to District the full amount as stated in Labor Code section 1777.7. Interpretation and enforcement of these provisions shall be in accordance with the rules and procedures of the California Apprenticeship Council and under the authority of the Chief of the Division of Apprenticeship Standards.

26.5.8. Contractor and all Subcontractors shall comply with Labor Code section 1777.6, which section forbids certain discriminatory practices in the employment of apprentices.

26.5.9. Contractor shall become fully acquainted with the law regarding apprentices prior to commencement of the Work. Special attention is directed to sections 1777.5, 1777.6, and 1777.7 of the Labor Code, and title 8, California Code of Regulations, section 200 et seq. Questions may be directed to the State Division of Apprenticeship Standards, 455 Golden Gate Avenue, San Francisco, California 94102.

26.5.10. Contractor shall ensure compliance with all certification requirements for all workers on the Project including, without limitation, the requirements for electrician certification in Labor Code sections 108, et seq.

26.6. Non-Discrimination

26.6.1. Contractor herein agrees not to discriminate in its recruiting, hiring, promotion, demotion, or termination practices on the basis of race, religious creed, national origin, ancestry, sex, age, or physical handicap in the performance of this Contract and to comply with the provisions of the California Fair Employment and Housing Act as set forth in part 2.8 of division 3 of the California Government Code, commencing at section 12900; the Federal Civil Rights Act of 1964, as set forth in Public Law 88-352, and all amendments thereto; Executive Order 11246, and all administrative rules and regulations found to be applicable to Contractor and Subcontractor.

26.6.2. Special requirements for Federally Assisted Construction Contracts: During the performance of this Contract, Contractor agrees to incorporate in all subcontracts the provisions set forth in Chapter 60-1.4(b) of Title 41 published in Volume 33 No. 104 of the Federal Register dated May 28, 1968.

26.7. Labor First Aid

Contractor shall maintain emergency first aid treatment for Contractor's workers on the Project which complies with the Federal Occupational Safety and Health Act of 1970 (29 U.S.C. § 651 et seq.) the California Occupational Safety and Health Act of 1973, and all related regulations, including without limitation section 330 et seq. of Title 8 of the California Code of Regulations.

27. MISCELLANEOUS

27.1. Assignment of Antitrust Actions

27.1.1. Section 7103.5(b) of the Public Contract Code states:

In entering into a public works contract or subcontract to supply goods, services, or materials pursuant to a public works contract, the Contractor or subcontractor offers and agrees to assign to the awarding body all rights, title, and interest in and to all causes of action it may have under Section 4 of the Clayton Act (15 U.S.C. Sec. 15) or under the Cartwright Act (Chapter 2 (commencing with Section 16700) of Part 2 of Division 7 of the Business and Professions Code), arising from purchases of goods, made and become effective at the time the awarding body tenders final payment to the Contractor, without further acknowledgment by the parties.

27.1.2. Section 4552 of the Government Code states:

In submitting a bid to a public purchasing body, the bidder offers and agrees that if the bid is accepted, it will assign to the purchasing body all rights, title, and interest in and to all causes of action it may have under Section 4 of the Clayton Act (15 U.S.C. Sec. 15) or under the Cartwright Act (Chapter 2 (commencing with Section 16700) of Part 2 of Division 7 of the Business and Professions Code), arising from purchases of goods, materials, or services by the bidder for sale to the purchasing body pursuant to the bid. Such assignment shall be made and become effective at the time the purchasing body tenders final payment to the bidder.

27.1.3. Section 4553 of the Government Code states:

If an awarding body or public purchasing body receives, either through judgment or settlement, a monetary recovery for a cause of action assigned under this chapter, the assignor shall be entitled to receive reimbursement for actual legal costs incurred and may, upon demand, recover from the public body any portion of the recovery, including treble damages, attributable to overcharges that were paid by the assignor but were not paid by the public body as part of the bid price, less the expenses incurred in obtaining that portion of the recovery.

27.1.4. Section 4554 of the Government Code states:

Upon demand in writing by the assignor, the assignee shall, within one year from such demand, reassign the cause of action assigned under this part if the assignor has been or may have been injured by the violation of law for which the cause of action arose and (a) the assignee has not been injured thereby, or (b) the assignee declines to file a court action for the cause of action.

27.1.5. Under this Article, "public purchasing body" is District and "bidder" is Contractor.

27.2. Excise Taxes

If, under Federal Excise Tax Law, any transaction hereunder constitutes a sale on which a Federal Excise Tax is imposed and the sale is exempt from such Federal Excise Tax because it is a sale to a State or Local Government for its exclusive use, District, upon request, will execute documents necessary to show (1) that District is a political subdivision of the State for the purposes of such exemption, and (2) that the sale is for

the exclusive use of District. No Federal Excise Tax for such materials shall be included in any Contract Price.

27.3. Taxes

Contract Price is to include any and all applicable sales taxes or other taxes that may be due in accordance with section 7051 of the Revenue and Taxation Code; Regulation 1521 of the State Board of Equalization or any other tax code that may be applicable.

27.4. Shipments

All shipments must be F.O.B. destination to Site or sites, as indicated in the Contract Documents. There must be no charge for containers, packing, unpacking, drayage, or insurance. The total Contract Price shall be all inclusive (including sales tax) and no additional costs of any type will be considered.

27.5. Compliance with Government Reporting Requirements

If this Contract is subject to federal or other governmental reporting requirements because of federal or other governmental financing in whole or in part for the Project which it is part, or for any other reason, Contactor shall comply with those reporting requirements at the request of the District at no additional cost.

END OF DOCUMENT